

# nicoline

**PHILOSOPHY**

Sofas





*Chapter 01 \_ Sofas / Divani*



*Chapter 02 \_ Photo description / Descrizione foto*



*Chapter 03 \_ Technical Sheets / Disegni tecnici*



Amalfi, Astedio, Aura, Bora,  
Bovisa, Bric, Cadorna, Cairoli,  
Cairoli Deep, Crumble, Egeo,  
Gary, Nausicaa, Pacific Square,  
Penta, Play, Strauss,  
Zara, Zara Deep, Zara Light.

## Index / Indice

**Amalfi**  
pag. 42 - 55



**Astedio**  
pag. 80 - 97



**Aura**  
pag. 24 - 41



**Bora**  
pag. 98 - 107



**Bovisa**  
pag. 134 - 145



**Bric**  
pag. 214 - 225



**Cadorna**  
pag. 124 - 133



**Cairoli - Cairoli Deep**  
pag. 146 - 163



**Crumble**  
pag. 12 - 23



**Egeo**  
pag. 226 - 239



**Gary**  
pag. 56 - 65



**Nausicaa**  
pag. 194 - 201



**Pacific Square**  
pag. 202 - 213





**Penta**  
pag. 164 - 173



**Play**  
pag. 108 - 123



**Strauss**  
pag. 66 - 79



**Zara - Zara Light - Zara Deep**  
pag. 174 - 193



Spazio come racconto del vuoto, della materia di cui si genera. Superfici, tagli, angoli, aperture, ombre sono la grammatica che lo definisce. Gli oggetti, gli arredi sono le parole che lo attraversano, dotate di un senso infallibile della misura e delle proporzioni. Nello spazio loro assegnato, trovano senso e risalto, diventandone i protagonisti del vivere quotidiano.

*Space as a tale of emptiness, of the matter from which it is generated. A mix of details defines the entire collection. The objects, the furnishings are the words that pass through it, endowed with an infallible sense of measure and proportions. In the space assigned to them, they find meaning and prominence, becoming the protagonists of everyday life.*





Con questa nuova collezione, Nicoline propone dei prodotti flessibili e dalle connotazioni poetiche inaspettate. Una proposta resa completa e versatile dalla varietà di forme e dalle generose profondità delle sedute, dalle diverse finiture di piedini e con imbottiture sui sedili e cuscini per aiutare ad accentuare il senso di morbidezza.

*With this new collection, Nicoline offers versatile products with unexpected poetic details. Such a complete proposal enriched by the variety of the shapes, the generous depths of the seats, the different finish options of legs: everything to help and facilitate the sense of softness of the cushions.*

Crumble sofa,  
Picasso coffee table.



# Crumble

Crumble è la rappresentazione assoluta della morbidezza. La progettualità crea sedute dalla forma sensuale e accogliente, generosamente armoniosa. Caratterizzato dallo schienale rivestito in maniera estremamente ricercata, realizzato completamente a mano che lo rende un pezzo unico.

*Crumble is the absolute representation of softness. The design creates seats with a sensual and welcoming shape, the harmony is characterized by the backrest completely handmade and a rare excellence artisanship creating special and unique pieces.*



Crumble sofa,  
Soufflé armchair,  
Picasso coffee table.







Crumble sofa,  
Soufflé armchair,  
Picasso coffee table.



Crumble sofa,  
Nest armchair,  
Nest pouf,  
Botero coffee table.







Crumble sofa,  
Botero coffee table.





Crumble sofa,  
Botero coffee table.







# Aura

Linee classiche, schienale curvo e una particolare trapuntatura che corre lungo lo schienale, unito al dettaglio dei piedini in metallo, donano una sensazione di eleganza e raffinatezza che rendono il divano Aura adatto ad ogni ambiente. Grazie ai diversi moduli si possono creare composizioni lineari o a L per un comfort davvero su misura.

*Classic lines, curved back and a unique quilting that runs along the seat combined with the detail of the metal legs, give a sophisticated and elegant touch that make the Aura sofa suitable for any setting. Thanks to a wide range of modular elements, linear or L-shaped compositions can be created for a truly tailor-made comfort.*



Aura sofa,  
Nest armchair,  
Grancircolo coffee table,  
Round coffee table.



Aura sofa,  
Nest armchair,  
Nest pouf,  
Grancircolo coffee table,  
Round coffee table.











Aura sofa,  
Grancircolo coffee table,  
Round coffee table.

Aura sofa,  
Proust armchair,  
Matisse coffee table,  
Botero coffee table.







Aura sofa,  
Proust armchair,  
Botero coffee table.





Aura sofa,  
Proust armchair,  
Matisse coffee table,  
Botero coffee table.





Aura sofa,  
Fashion armchair,  
Round coffee table,  
Circolo coffee table.













# Amalfi

Amalfi è un divano dalle forme sinuose e sensuali. Ispirato a forme organiche che richiamano il design anni Settanta. Trasforma qualsiasi spazio in un paesaggio elegante e raffinato diventandone il protagonista.

*Amalfi is a sofa with sinuous and sensual shapes. Inspired by organic shapes that recall the seventies design, it transforms any space into an elegant and refined landscape, becoming the protagonist.*

Amalfi sofa,  
Madeleine swivel armchair,  
Botero coffee table.

















Amalfi sofa,  
Diga armchair,  
Botero coffee table.













Amalfi sofa,  
Soufflé armchair,  
Matisse coffee table.

Gary sofa,  
Dot pouf,  
Diga armchair.



# Gary

*Design* Maurizio Manzoni

Divano modulare dalle proporzioni eleganti e dalle linee rassicuranti. Con rivestimenti in tessuto o pelle, Gary cita le classiche tipologie capitonné, attualizzandole con uno stile di vita più libero e informale. Del progetto fanno parte divani lineari, composizioni angolari, chaises longue.

*A modular sofa with elegant proportions and reassuring shapes. Whether in fabric or in leather, Gary highlights the classic capitonné typologies, shown in a modern view and with a free and more informal lifestyle. The concept includes linear sofas, corner compositions, chaises longues.*







Gary sofa,  
Fly Small coffee table.



Gary sofa,  
Diga armchair,  
Grancircolo coffee table,  
Dot pouf.













## Strauss

Strauss è un sistema modulare in grado di rispondere a differenti esigenze di comfort e di postura grazie a un meccanismo di facile utilizzo che consente di variare l'altezza di schienale e la profondità di seduta.

*Strauss is a modular system able to meet different requirements of comfort and posture thanks to an easy-to-use mechanism that allows to change the height of the backrest and the depth of the seat.*





Strauss sofa,  
Nicole armchair,  
Grancircolo coffee table.



Strauss sofa,  
Matisse coffee table,  
Dalí coffee table.











Strauss sofa,  
Dia armchair,  
Monet coffee table.





Strauss sofa,  
Lady Swivel armchair,  
Metrico coffee table.









Astedio sofa,  
Renoir coffee table.



# Astedio

*Design* Maurizio Manzoni

Astedio è un divano classico ma contemporaneo, dall'apparente semplicità formale data dall'essenzialità del disegno, capace di offrire un comfort avvolgente grazie alle sue proporzioni generose.

*Astedio is a classic sofa but at the same time contemporary. The formal simplicity design aspect offers generous proportions with embrace comfort.*



Astedio sofa,  
Luis armchair,  
Renoir coffee table.





Astedio sofa,  
Luis armchair,  
Renoir coffee table.





Astedio sofa,  
Luis armchair,  
Dalí coffee table,  
Renoir coffee table.





Astedio sofa,  
Diga Swivel armchair,  
Renoir coffee table,  
Dalí coffee table.











Astedio sofa,  
Rondò armchair,  
Picasso coffee table.



Astedio sofa,  
Proust armchair,  
Picasso coffee table.













## Bora

Il divano Bora nasce per essere comodo e allo stesso tempo leggero. Dotato di un comfort unico grazie all'avvolgente cuscinatura. Bora è caratterizzato da piedini sagomati che ne determinano il tratto distintivo.

*The Bora sofa was created to be comfortable and at the same time light. Equipped with a unique comfort thanks to the enveloping cushions. Bora is characterized by shaped legs that determine its distinctive feature.*



Bora sofa,  
Grancircolo coffee table,  
Circolo coffee table,  
Main pouf.





Bora sofa,  
Bea Low armchair,  
Shiny coffee table,  
Main pouf.











Bora sofa,  
Grancircolo coffee table,  
Circolo coffee table.





# Play

*Design* Maurizio Manzoni

Un divano dalle forme morbide e rassicuranti, in cui la possibilità di movimento dello schienale, l'aspetto soffice e l'imbottitura esaltano il comfort dando vita a molteplici interpretazioni.

*A sofa with soft and embracing shapes, where the manual movable back and the rich padding on the seat, enhance the comfort, giving multiple interpretations.*



Play sofa,  
Fashion armchair,  
Metrico coffee table,  
Shiny coffee table.







Play sofa,  
Shiny coffee table.

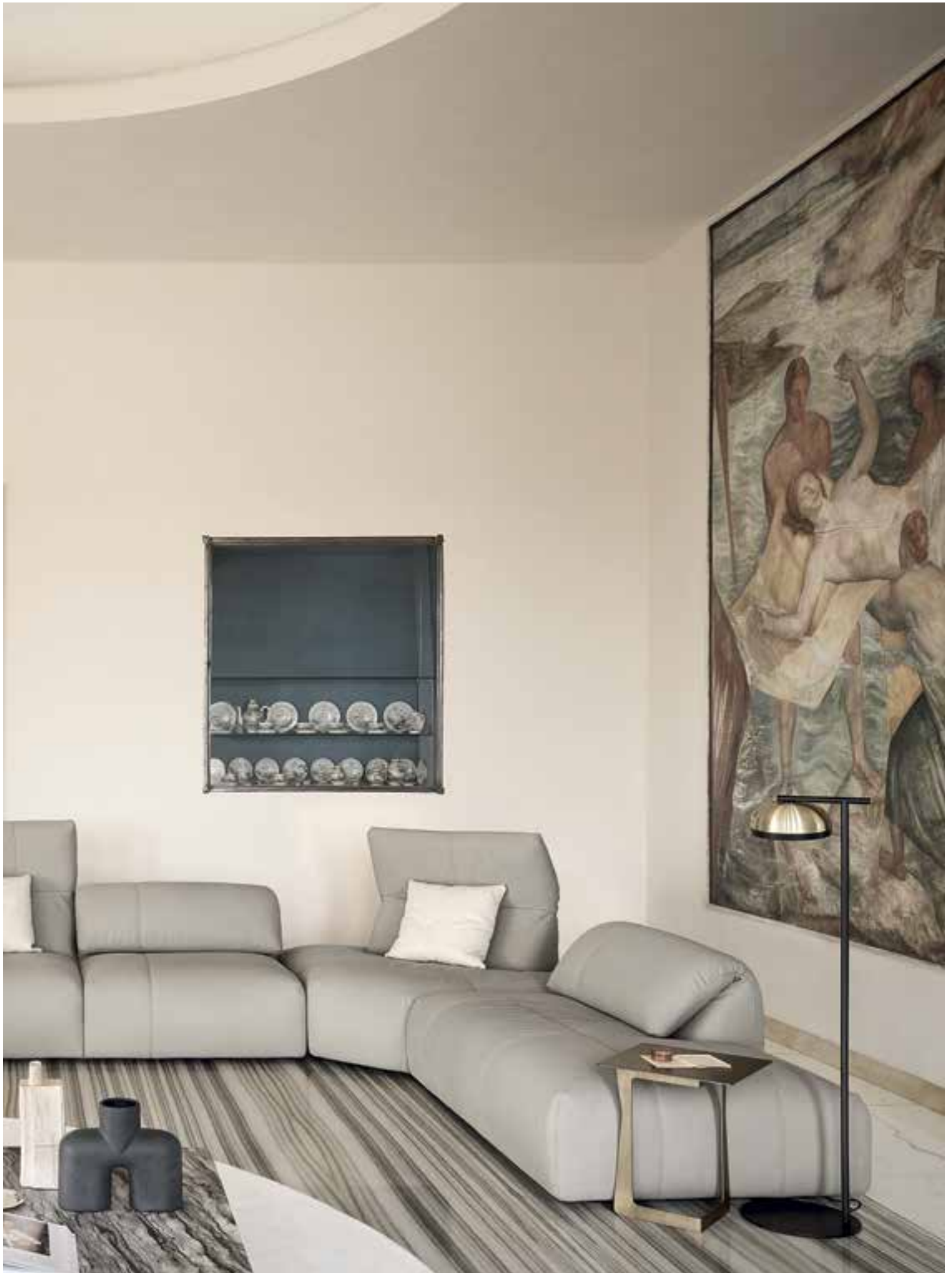



Play sofa,  
Nicole armchair,  
Grancircolo coffee table,  
Circolo coffee table,  
Round coffee table.





Proporzioni generose e grande personalità per il divano Play nelle versioni con bracciolo Big. Un'estetica ultrabold per un archetipo dell'imbottito, che riconduce ogni elemento alla sua forma primaria. Una proposta elegante e completa per le atmosfere più classiche del living. Play in pelle ROYAL 2365.

*Generous proportions and high-impact for the Play sofa in versions with Big armrest. An ultrabold look for an archetype of upholstery, which brings each element back to its primary form. An elegant and complete package for the most classic setting of the living room. Play in leather ROYAL 2365.*





Play sofa,  
Botero coffee table,  
Main pouf.







Play sofa,  
Botero coffee table,  
Main pouf.











## Cadorna

Il divano Cadorna nasce per essere comodo e allo stesso tempo leggero. Dotato di un comfort unico grazie all'avvolgente cuscinatura in piuma. Cadorna è caratterizzato da piedini sagomati che ne determinano il tratto distintivo.

*The Cadorna sofa was created to be comfortable and at the same time light. Equipped with a unique comfort thanks to the enveloping feather cushions. Cadorna is characterized by shaped legs that determine its distinctive feature.*

Cadorna sofa,  
Fashion armchair,  
Matisse coffee table,  
Mondrian coffee table.













Cadorna sofa,  
Cadorna bench,  
Bea High armchair,  
Bea High pouf,  
Metrico coffee table,  
Metrico Small coffee table.





Cadorna sofa,  
Cadorna bench,  
Bea High armchair.







## Bovisa

Divano dal design tradizionale, facilmente adattabile a qualsiasi ambiente. I dettagli attribuiscono al Bovisa un'identità unica ed inconfondibile.

*Sofa with traditional design, easily adaptable to any environment. The details give the Bovisa a unique and incomparable identity.*



Bovisa sofa,  
Ghirla armchair,  
Matisse coffee table.













Bovisa sofa,  
Metrico coffee table,  
Plane coffee table.





Bovisa sofa,  
Julie armchair,  
Metrico coffee table.





## Cairolì - Cairolì Deep

Cairolì è un modello modulare caratterizzato da un comfort soffice e sedute accoglienti. La combinazione delle versioni del Cairolì con quelle del Cairolì Deep, rendono il modello flessibile.

*The Cairolì sofa is a modular model characterized by soft and comfortable seats. The combination of the Cairolì and Cairolì Deep pieces makes the model flexible.*



Cairoli Deep and Cairoli sofa,  
Proust armchair,  
Picasso coffee table.









Cairoli Deep sofa,  
Madeleine swivel armchair,  
Matisse coffee table.









Cairoli sofa,  
Dalí coffee table,  
Botero coffee table.





Cairoli sofa,  
Gioia armchair,  
Monet coffee table,  
Mondrian coffee table.











Cairoli sofa,  
Gioia armchair,  
Monet coffee table,  
Picasso coffee table,  
Mondrian coffee table.



Cairoli sofa,  
Gioia armchair,  
Picasso coffee table,  
Mondrian coffee table.





## Penta

Penta è un divano dalla struttura avvolgente che accoglie morbidi cuscini di seduta e schienale restituendo un'immagine morbida e confortevole. Grazie a imbottiture particolarmente generose e dettagli che ne ammorbidiscono le geometrie offre una soluzione sia formale che accogliente e rilassata.

*Penta sofa with enveloping structure that welcomes soft seat and back cushions in a soft and comfortable image. Thanks to particularly generous paddings and details that soften its geometries, offers a solution that is both formal, welcoming and relaxed.*



Penta sofa,  
Picasso coffee table.









Penta sofa,  
Nicole armchair,  
Botero coffee table,  
Dalí coffee table.













## Zara - Zara Light - Zara Deep

Dal design lineare e pulito, il divano Zara è impreziosito da cuciture ribattute con inserto centrale in contrasto. Lo Zara è facilmente combinabile con le versioni dello Zara Light, con braccio in pelle, e dello Zara Deep con seduta più profonda.

*With clean and simple design, Zara sofa is enhanced by stitched seams with a contrasting or matching central insert. Zara Model, can be easily combined with the pieces of the Zara Light with leather arm, and the Zara Deep with deeper seat.*



Zara Deep sofa,  
Botero coffee table.





Zara Deep sofa,  
Botero coffee table.





Zara Deep sofa,  
Renoir coffee table,  
Dalí coffee table.





Zara Deep sofa,  
Plane coffee table.







Zara sofa,  
Zara Deep sofa,  
Circolo coffee table,  
Round coffee table.



Zara sofa,  
Zara Deep sofa,  
Circolo coffee table,  
Round coffee table.







Zara sofa,  
Zara Light sofa,  
Monet coffee table,  
Mondrian coffee table.







Zara sofa,  
Zara Light sofa,  
Ghirla armchair,  
Monet coffee table,  
Plane coffee table.



Zara



Zara Deep



Zara Light



Tutte le versioni dei modelli Zara, Zara Deep, Zara Light sono combinabili tra loro.

*All versions of Zara, Zara Deep, Zara Light can be combined with each other.*



# Nausicaa

Semplice, lineare, raffinato. Nausicaa è un modello che si adatta ad ogni tipo di ambiente. Versatile e dinamico, si presta a diverse composizioni. Un elegante bordino traccia i contorni e ne esalta le forme. Disponibile in pelle o tessuto.

*Simple, linear, refined. Nausicaa is a versatile and dynamic model that adapts to any type of environment. An elegant piping traces the contours and enhances the shapes. Available in leather or fabric.*











Nausicaa sofa,  
Rondò armchair,  
Matisse coffee table,  
Mondrian coffee table,





Pacific Square sofa,  
Dalí coffee table.



## *Pacific Square*

Pacific Square è un modello dalle linee geometriche lineari e pulite, impreziosito da una cucitura speciale sullo schienale, ripresa anche sul poggiatesta. I piedi in metallo contribuiscono a slanciarlo e a donare un piccolo tocco di eleganza ad uno stile chiaramente moderno.

*Pacific Square is a model with linear and clean geometric lines, embellished with a special stitching on the back and the headrest. The thin metal legs give a small touch of elegance to a clearly modern style.*



Pacific Square sofa,  
Rho armchair,  
Metrico coffee table,  
Plane coffee table,  
Circolo coffee table,  
Shiny coffee table.

















Pacific Square sofa,  
Proust armchair,  
Matisse coffee table,  
Plane coffee table.





Bric sofa,  
Picasso coffee table,  
Dalí coffee table.





## *Bric*

Semplice e geometrico, il modello Bric è ideale in ambienti moderni. I disegni verticali creati dalle cuciture artigianali lo rendono unico ed originale. Disponibile in pelle o tessuto.

*Simple and geometric, the Bric model is ideal in modern environments. The vertical patterns created by the handmade stitching make it unique and original. Available in leather or fabric.*



Bric sofa,  
Bea High armchair,  
Picasso coffee table,  
Dalí coffee table.























## *Egeo*

Dalle forme lineari e rigorose, l'Egeo è sinonimo di comfort assoluto. La cucitura "tirata" sulla seduta riprende l'estetica della tradizione "boudoir" in chiave contemporanea e minimale.

*With linear and rigorous shapes, the Egeo is synonymous of absolute comfort taking up the aesthetics of the "boudoir" tradition in a contemporary and minimal key.*



Egeo sofa,  
Nest Swivel armchair,  
Grancircolo coffee table,  
Circolo coffee table,  
Fly Small coffee table.















Egeo sofa,  
Fashion armchair,  
Picasso coffee table,  
Mondrian coffee table.









Egeo sofa,  
Picasso coffee table,  
Plane coffee table.





Descrizione foto e  
disegni tecnici

*Photo description and  
Technical Sheets*

**Nota** | I colori e le textures di pelle e tessuti sono da considerarsi puramente indicativi in quanto potrebbero esserci variazioni di colori, effetti rispetto alla realtà. Si prega di far riferimento al campionario rivestimenti.  
**Note** | The colors and textures of leather and fabrics are to be considered purely indicative as they could be variations of colors, effects compared to reality. Please refer to the samples to select them.





## AMALFI p.44-45

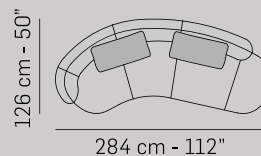

**Divano Amalfi (Cod.3022)** n° 2 Tessuto | Por Col.01 Cat.G - Atelier Collection

**Cuscino** CU81 Tessuto | Coc Col.00 Cat.G - Atelier Collection

**Poltrona Madeleine Swivel (Cod.1390)** n° 2 Tessuto | Coc Col.00 Cat.G - Atelier Collection - Base girevole | Legno finitura nero

**Tavolino Botero (Cod.9511)** n° 2 Ripiano | marmo Calacatta Bluette (Cod.CB) - Struttura | marmo Calacatta Bluette (Cod.CB)

**Amalfi sofa (Cod.3022)** n° 2 Fabric | Por Col.01 Cat.G - Atelier Collection

**Pillow** CU81 Fabric | Coc Col.00 Cat.G - Atelier Collection

**Madeleine Swivel armchair (Cod.1390)** n° 2 Fabric | Coc Col.00 Cat.G - Atelier Collection - Swivel base | Wooden base in black color

**Botero coffee table (Cod.9511)** n° 2 Top | Calacatta Bluette marble (Cod.CB) - Structure | Calacatta Bluette marble (Cod.CB)



## AMALFI p.50-51

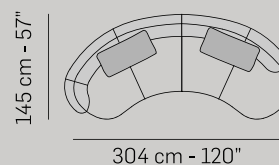

**Divano Amalfi (Cod.1902\*1631)** Tessuto | Coc Col.00 Cat.G - Atelier Collection

**Cuscini** CU81 Tessuto | Coc Col.00 Cat.G - Atelier Collection - CU81 Tessuto | Per Col.01 Cat.D - Flair Collection - CU51 Tessuto | Coc Col.00 Cat.G - Atelier Collection

**Poltrona Diga (Cod.1000)** Pelle/Tessuto | Passanti: Nevada 2417 Cat.2000 - Scocca, bordino, cuscini di seduta e spalliera: Por Col.22 Cat.G - Atelier Collection - Piede | metallo Bronzo Anticato (Cod.52) con parte inferiore verniciata in Oro Satinato

**Tavolino Botero (Cod.9511\*9512)** Ripiano | marmo Verde Alpi (Cod.VA) - Struttura | marmo Verde Alpi (Cod.VA)

**Amalfi sofa (Cod.1902\*1631)** Fabric | Coc Col.00 Cat.G - Atelier Collection

**Pillows** CU81 Fabric | Coc Col.00 Cat.G - Atelier Collection - CU81 Fabric | Per Col.01 Cat.D - Flair Collection - CU51 Fabric | Coc Col.00 Cat.G - Atelier Collection

**Diga armchair (Cod.1000)** Leather/Fabric | Belt loops: Nevada 2417 Cat.2000 - Frame, piping, seat and back cushions: Por Col.22 Cat.G - Atelier Collection - Legs | Antique Bronze metal (Cod.52) with lower part painted in Matte Gold color

**Botero coffee table (Cod.9511\*9512)** Top | Verde Alpi marble (Cod.VA) - Structure | Verde Alpi marble (Cod.VA)



## AMALFI p.54-55

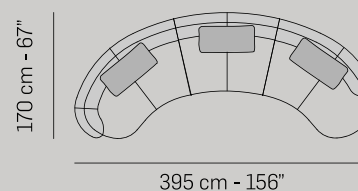

**Divano Amalfi (Cod.1902+4015+1631)** Tessuto | Coc Col.00 Cat.G - Atelier Collection

**Cuscini** CU81 Tessuto | Coc Col.00 Cat.G - Atelier Collection - CU81 Tessuto | Per Col.01 Cat.D - Flair Collection - CU51 Tessuto | Coc Col.00 Cat.G - Atelier Collection - CU51 n° 2 Tessuto | Reg Col.33 Cat.G - Pure Velvet Collection

**Poltrona Soufflé (Cod.1000)** n° 2 Tessuto | Reg Col.33 Cat.G - Pure Velvet Collection - Piede e bottone | metallo Canna di Fucile (Cod.50)

**Tavolino Matisse (Cod.9512+9513)** Ripiano | marmo Nero Marquinia (Cod.NM) - Struttura | metallo Grigio Piombo (Cod.57)

**Amalfi sofa (Cod.1902+4015+1631)** Fabric | Coc Col.00 Cat.G - Atelier Collection

**Pillows** CU81 Fabric | Coc Col.00 Cat.G - Atelier Collection - CU81 Fabric | Per Col.01 Cat.D - Flair Collection - CU51 Fabric | Coc Col.00 Cat.G - Atelier Collection - CU51 n° 2 Fabric | Reg Col.33 Cat.G - Pure Velvet Collection

**Soufflé armchair (Cod.1000)** n° 2 Fabric | Reg Col.33 Cat.G - Pure Velvet Collection - Legs and button | Gunmetal (Cod.50)

**Matisse coffee table (Cod.9512+9513)** Top | Black Marquinia marble (Cod.NM) - Structure | Lead Grey metal (Cod.57)



## ASTEDIO p.82-83

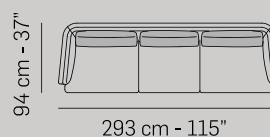

**Divano Astedio (Cod.3160)** Tessuto | Mio Col.01 Cat.G - Atelier Collection - Piedini | metallo Canna di Fucile (Cod.50)

**Cuscini** CU51 n° 2 Tessuto | Reg Col.59 Cat.G - Pure Velvet Collection

**Poltrona Luis (Cod.1000)** n° 2 Tessuto | Por Col.03 Cat.G - Atelier Collection - Profilo Bracciolo | Legno Rovere Termocotto (Cod.11) - Struttura | metallo Canna di Fucile (Cod.50)

**Tavolino Renoir (Cod.9511)** Ripiano | marmo Sahara Noir (Cod.SN) - Struttura | metallo Titanio (Cod.58)

**Astedio sofa (Cod.3160)** Fabric | Mio Col.01 Cat.G - Atelier Collection - Legs | Gunmetal (Cod.50)

**Pillows** CU51 n° 2 Fabric | Reg Col.59 Cat.G - Pure Velvet Collection

**Luis armchair (Cod.1000)** n° 2 Fabric | Por Col.03 Cat.G - Atelier Collection - Armrest Top | Beech wood Thermobaked Oak (Cod.11) - Structure | Gunmetal (Cod.50)

**Renoir coffee table (Cod.9511)** Top | Sahara Noir marble (Cod.SN) - Structure | Titanium metal (Cod.58)



**Divano Astedio (Cod.3000)** Pelle | Nevada 2417 Cat.2000 - Piedini | metallo Canna di Fucile (Cod.50)

**Divano Astedio (Cod.3031)** Pelle | Nevada 2417 Cat.2000 - Piedini | metallo Canna di Fucile (Cod.50) - Ripiano | marmo Patagonia (Cod.PA)

**Cuscini** CU51 n° 2 Tessuto | Reg Col.34 Cat.G - Pure Velvet Collection - CU81 Tessuto | Amo CoLo8 Cat.G - Atelier Collection

**Poltrona Diga Swivel (Cod.1360)** Tessuto | Ica Col.17 Cat.G - Atelier Collection - Base girevole | metallo Bronzo Anticato (Cod.52)

**Tavolino Renoir (Cod.9511)** n° 2 Ripiano | marmo Sahara Noir (Cod.SN) - Struttura | metallo Grigio Sabbia (Cod.56)

**Tavolino Dalí (Cod.9511)** Ripiano | marmo Nero Marquinia (Cod.NM) - Struttura | metallo Grigio Sabbia (Cod.56)

## ASTEDIO p.88-89

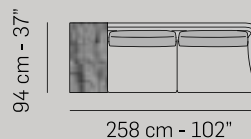
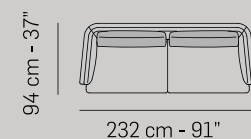

**Astedio sofa (Cod.3000)** Leather | Nevada 2417 Cat.2000 - Legs | Gunmetal (Cod.50)

**Astedio sofa (Cod.3031)** Leather | Nevada 2417 Cat.2000 - Legs | Gunmetal (Cod.50) - Top | Patagonia marble (Cod.PA)

**Pillows** CU51 n° 2 Fabric | Reg Col.34 Cat.G - Pure Velvet Collection - CU81 Fabric | Amo CoLo8 Cat.G - Atelier Collection

**Diga Swivel armchair (Cod.1360)** Fabric | Ica Col.17 Cat.G - Atelier Collection - Swivel base | Antique Bronze metal (Cod.52)

**Renoir coffee table (Cod.9511)** n° 2 Top | Sahara Noir marble (Cod.SN) - Structure | Sand Grey metal (Cod.56)

**Dalí coffee table (Cod.9511)** Top | Black Marquinia marble (Cod.NM) - Structure | Sand Grey metal (Cod.56)



**Divano Astedio (Cod.3031)** Pelle | Nevada 2417 Cat.2000 - Piedini | metallo Canna di Fucile (Cod.50) - Ripiano | marmo Patagonia (Cod.PA)

**Cuscino** CU57 Tessuto | Reg Col.70 Cat.G - Pure Velvet Collection

**Poltrona Rondò (Cod.1000\*9010)** Tessuto | Dod CoL07 Cat.G - Tech Velvet Collection - Piede | Legno finitura Wengé (Cod.05)

**Tavolino Picasso (Cod.9511)** Ripiano | marmo Blu Roma (Cod.BR) - Struttura | metallo Grigio Sabbia (Cod.56)

## ASTEDIO p.92-93

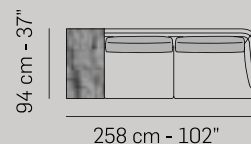

**Astedio sofa (Cod.3031)** Leather | Nevada 2417 Cat.2000 - Legs | Gunmetal (Cod.50) - Top | Patagonia marble (Cod.PA)

**Pillow** CU57 Fabric | Reg Col.70 Cat.G - Pure Velvet Collection

**Rondò armchair (Cod.1000\*9010)** Fabric | Dod CoL07 Cat.G - Tech Velvet Collection - Legs | Wooden legs in Wengé (Cod.05)

**Picasso coffee table (Cod.9511)** Top | Blu Roma marble (Cod.BR) - Structure | Sand Grey metal (Cod.56)



## ASTEDIO p.94-95

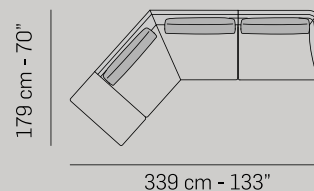

**Divano Astedio (Cod.3122+1201)** Pelle/Tessuto | Scocca: Royal 2367 Cat.2000 - Cuscinatura: Mem Col.01 Cat.G - Atelier Collection - Piedini | metallo Canna di Fucile (Cod.50)

**Cuscini** CU51 Tessuto | Coc Col.09 Cat.G - Atelier Collection - CU51 Tessuto | Mem Col.01 Cat.G - Atelier Collection

**Poltrona Proust (Cod.1000)** Tessuto | Reg Col.48 Cat.G - Pure Velvet Collection - Piede | metallo Ottone Satinato (Cod.51)

**Tavolino Picasso (Cod.9512)** Ripiano | marmo Blu Roma (Cod.BR) - Struttura | metallo Grigio Sabbia (Cod.56)

**Astedio sofa (Cod.3122+1201)** Leather/Fabric | Frame: Royal 2367 Cat.2000 - Back and seat cushions, armrest: Mem Col.01 Cat.G - Atelier Collection - Legs | Gunmetal (Cod.50)

**Pillows** CU51 Fabric | Coc Col.09 Cat.G - Atelier Collection - CU51 Fabric | Mem Col.01 Cat.G - Atelier Collection

**Proust armchair (Cod.1000)** Fabric | Reg Col.48 Cat.G - Pure Velvet Collection - Legs | Satin Brass metal (Cod.51)

**Picasso coffee table (Cod.9512)** Top | Blu Roma marble (Cod.BR) - Structure | Sand Grey metal (Cod.56)



## AURA p.26-27

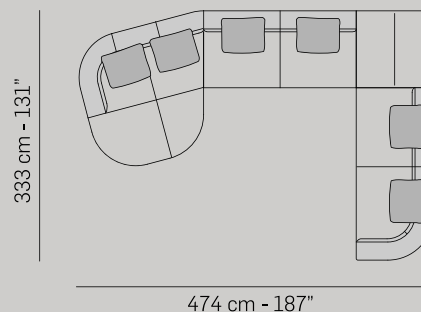

**Divano Aura (Cod.5142+3203+8015+3201)** Tessuto | Por Col.26 Cat.G - Atelier Collection - Piedini | metallo Canna di Fucile (Cod.50)

**Cuscini** CU51 n° 2 Tessuto | Reg Col.06 Cat.G - Pure Velvet Collection

**Poltrona Nest (Cod.1000)** Pelle | Colorado 2553 Cat.2500 - Piede | metallo Canna di Fucile (Cod.50)

**Tavolino Round (Cod.9502)** Ripiano | marmo Bianco Carrara (Cod.CA) - Struttura | metallo Canna di Fucile (Cod.50)

**Tavolino Grancircolo (Cod.9502)** Ripiano | marmo Nero Marquinia (Cod. NM) - Struttura | metallo Canna di Fucile (Cod.50)

**Aura sofa (Cod.5142+3203+8015+3201)** Fabric | Por Col.26 Cat.G - Atelier Collection - Legs | Gunmetal (Cod.50)

**Pillows** CU51 n° 2 Fabric | Reg Col.06 Cat.G - Pure Velvet Collection

**Nest armchair (Cod.1000)** Leather | Colorado 2553 Cat.2500 - Legs | Gunmetal (Cod.50)

**Round coffee table (Cod.9502)** Top | White Carrara marble (Cod.CA) - Structure | Gunmetal (Cod.50)

**Grancircolo coffee table (Cod.9502)** Top | Black Marquinia marble (Cod. NM) - Structure | Gunmetal (Cod.50)



**Divano Aura (Cod.S3002+4071)** Tessuto | Ica Col.07 Cat.G - Atelier Collection - Piedini | metallo Canna di Fucile (Cod.50)

**Cuscino CU57** Tessuto | Reg Col.48 Cat.G - Pure Velvet Collection

**Poltrona Proust (Cod.1000)** Tessuto | Reg Col.48 Cat.G - Pure Velvet Collection - Piede | metallo Ottone Satinato (Cod.51)

**Tavolino Matisse (Cod.9511+9512)** Ripiano | marmo Dover White (Cod. DW) - Struttura | metallo Grigio Piombo (Cod.57)

**Tavolino Botero (Cod.9512)** Ripiano | marmo Verde Alpi (Cod.VA) - Struttura | marmo Verde Alpi (Cod.VA)

## AURA p.32-33

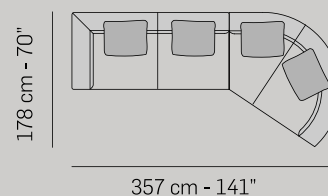

**Aura sofa (Cod.S3002+4071)** Fabric | Ica Col.07 Cat.G - Atelier Collection - Legs | Gunmetal (Cod.50)

**Pillow CU57** Fabric | Reg Col.48 Cat.G - Pure Velvet Collection

**Proust armchair (Cod.1000)** Fabric | Reg Col.48 Cat.G - Pure Velvet Collection - Legs | Satin Brass metal (Cod.51)

**Matisse coffee table (Cod.9511+9512)** Top | Dover White marble (Cod. DW) - Structure | Lead Grey metal (Cod.57)

**Botero coffee table (Cod.9512)** Top | Verde Alpi marble (Cod.VA) - Structure | Verde Alpi marble (Cod.VA)



**Divano Aura (Cod.5142+3201)** Tessuto | Por Col.26 Cat.G - Atelier Collection - Piedini | metallo Canna di Fucile (Cod.50)

**Cuscino CU81** Tessuto | Reg Col.34 Cat.G - Pure Velvet Collection

**Poltrona Fashion (Cod.1000)** Pelle/Tessuto | Scocca: Nevada 2412 Cat.2000 - Cuscini di seduta e spalliera: One Col.00 Cat.D - Flair Collection - Struttura | metallo Canna di Fucile (Cod.50)

**Tavolino Circolo (Cod.9502)** Ripiano | marmo Bianco Carrara (Cod.CA) - Struttura | metallo Canna di Fucile (Cod.50)

**Tavolino Grancircolo (Cod.9502)** Ripiano | marmo Bianco Carrara (Cod. CA) - Struttura | metallo Canna di Fucile (Cod.50)

## AURA p.38-39

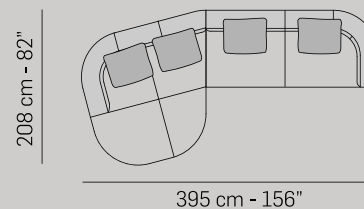

**Aura sofa (Cod.5142+3201)** Fabric | Por Col.26 Cat.G - Atelier Collection - Legs | Gunmetal (Cod.50)

**Pillow CU81** Fabric | Reg Col.34 Cat.G - Pure Velvet Collection

**Fashion armchair (Cod.1000)** Leather/Fabric | Frame: Nevada 2412 Cat.2000 - Seat and back cushions: One Col.00 Cat.D - Flair Collection - Structure | Gunmetal (Cod.50)

**Circolo coffee table (Cod.9502)** Top | White Carrara marble (Cod.CA) - Structure | Gunmetal (Cod.50)

**Grancircolo coffee table (Cod.9502)** Top | White Carrara marble (Cod. CA) - Structure | Gunmetal (Cod.50)





## BORA p.104-105

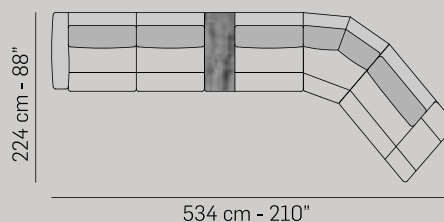

**Divano Bora (Cod.3002+1672+4015+1841)** Tessuto | Mem Col.01 Cat.G - Atelier Collection - Piedini | metallo Canna di Fucile (Cod.50) - Ripiano | marmo Bianco Carrara (Cod.CA)

**Cuscini** CU51 n° 2 Tessuto | Reg Col.34 Cat.G - Pure Velvet Collection - CU51 n° 2 Tessuto | Reg Col.59 Cat.G - Pure Velvet Collection - CU51 Tessuto | Mem Col.01 Cat.G - Atelier Collection

**Poltrona Bea Low (Cod.1000)** Pelle/Tessuto | Scocca e bordino: Royal 2353 Cat.2000 - Cuscini di seduta e spalliera: San Col.02 Cat.G - Atelier Collection - Piede | metallo Bronzo Anticato (Cod.52)

**Pouf Main (Cod.8015)** Tessuto | Reg Col.34 Cat.G - Pure Velvet Collection

**Tavolino Circolo (Cod.9502)** n° 1 Ripiano | marmo Bianco Carrara (Cod. CA) - Struttura | metallo Canna di Fucile (Cod.50) - n° 1 Ripiano | marmo Nero Marquinia (Cod.NM) - Struttura | metallo Canna di Fucile (Cod.50)

**Tavolino Grancircolo (Cod.9502)** Ripiano | marmo Bianco Carrara (Cod. CA) - Struttura | metallo Canna di Fucile (Cod.50)

**Tavolino Shiny (Cod.9502)** Ripiano | metallo Ottone Satinato (Cod.51) - Struttura | metallo Ottone Satinato (Cod.51)

**Bora sofa (Cod.3002+1672+4015+1841)** Fabric | Mem Col.01 Cat.G - Atelier Collection - Legs | Gunmetal (Cod.50) - Top | White Carrara marble (Cod.CA)

**Pillows** CU51 n° 2 Fabric | Reg Col.34 Cat.G - Pure Velvet Collection - CU51 n° 2 Fabric | Reg Col.59 Cat.G - Pure Velvet Collection - CU51 Fabric | Mem Col.01 Cat.G - Atelier Collection

**Bea Low armchair (Cod.1000)** Leather/Fabric | Frame and piping: Royal 2353 Cat.2000 - Seat and back cushions: San Col.02 Cat.G - Atelier Collection - Legs | Antique Bronze metal (Cod.52)

**Main footstool (Cod.8015)** Fabric | Reg Col.34 Cat.G - Pure Velvet Collection

**Circolo coffee table (Cod.9502)** n° 1 Top | White Carrara marble (Cod. CA) - Structure | Gunmetal (Cod.50) - n° 1 Top | Black Marquinia marble (Cod.NM) - Structure | Gunmetal (Cod.50)

**Grancircolo coffee table (Cod.9502)** Top | White Carrara marble (Cod. CA) - Structure | Gunmetal (Cod.50)

**Shiny coffee table (Cod.9502)** Top | Satin Brass metal (Cod.51) - Structure | Satin Brass metal (Cod.51)



## BOVISA p.136-137

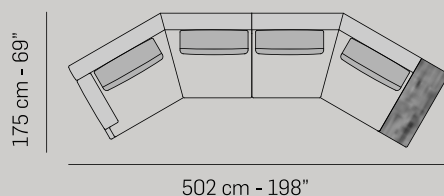

**Divano Bovisa (Cod.3092+3451)** Tessuto | Por Col.25 Cat.G - Atelier Collection - Piedini | metallo Bronzo Anticato (Cod.52) - Ripiano | marmo Nero Marquinia (Cod.NM)

**Cuscini** CU51 n° 2 Tessuto | Reg Col.34 Cat.G - Pure Velvet Collection - CU81 Tessuto | Lin Col.01 Cat.G - Atelier Collection

**Poltrona Ghirla (Cod.1360)** Pelle/Tessuto | Scocca: Colorado 2566 Cat.2500 - Cuscini di seduta e spalliera: Lin Col.01 Cat.G - Atelier Collection - Base girevole | Legno finitura Wengé (Cod.05)

**Tavolino Matisse (Cod.9512+9513)** Ripiano | marmo Dover White (Cod. DW) - Struttura | metallo Grigio Piombo (Cod.57)

**Bovisa sofa (Cod.3092+3451)** Fabric | Por Col.25 Cat.G - Atelier Collection - Legs | Antique Bronze metal (Cod.52) - Top | Black Marquinia marble (Cod.NM)

**Pillows** CU51 n° 2 Fabric | Reg Col.34 Cat.G - Pure Velvet Collection - CU81 Fabric | Lin Col.01 Cat.G - Atelier Collection

**Ghirla armchair (Cod.1360)** Leather/Fabric | Frame: Colorado 2566 Cat.2500 - Seat and back cushions: Lin Col.01 Cat.G - Atelier Collection - Swivel base | Wooden legs in Wengé (Cod.05)

**Matisse coffee table (Cod.9512+9513)** Top | Dover White marble (Cod. DW) - Structure | Lead Grey metal (Cod.57)



BOVISA p.142-143

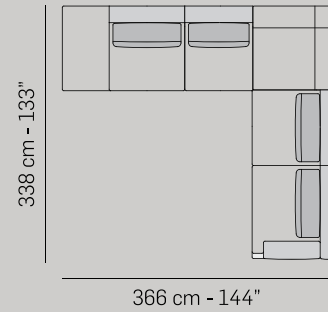

**Divano Bovisa (Cod.1602+1203+8093+3201)** Tessuto | Amo Col.08 Cat.G - Atelier Collection - Piedini | metallo Canna di Fucile (Cod.50)

**Bovisa sofa (Cod.1602+1203+8093+3201)** Fabric | Amo Col.08 Cat.G - Atelier Collection - Legs | Gunmetal (Cod.50)

**Tavolino Metrico (Cod.9502)** Ripiano | marmo Nero Marquinia (Cod. NM) - Struttura | metallo Canna di Fucile (Cod.50)

**Metrico coffee table (Cod.9502)** Top | Black Marquinia marble (Cod. NM) - Structure | Gunmetal (Cod.50)



BRIC p.220-221

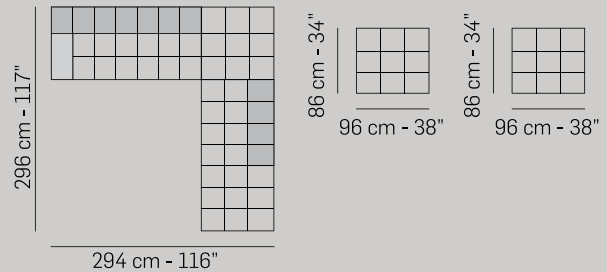

**Divano Bric (Cod.3002+8093+1631) (Cod.8027+8027)** Tessuto | Dod Col.33 Cat.G - Tech Velvet Collection

**Bric sofa (Cod.3002+8093+1631) (Cod.8027+8027)** Fabric | Dod Col.33 Cat.G - Tech Velvet Collection

**Cuscini CU51** Tessuto | Dod Col.33 Cat.G - Tech Velvet Collection - CU51 Tessuto | Coc Col.09 Cat.G - Atelier Collection - CU81 Tessuto | Coc Col.09 Cat.G - Atelier Collection

**Pillows CU51** Fabric | Dod Col.33 Cat.G - Tech Velvet Collection - CU51 Fabric | Coc Col.09 Cat.G - Atelier Collection - CU81 Fabric | Coc Col.09 Cat.G - Atelier Collection

**Poltrona Bea High (Cod.1000)** Pelle/Tessuto | Scocca e bordino: Nevada 2417 Cat.2000 - Cuscini di seduta e spalliera: One Col.00 Cat.D - Flair Collection - Piede | metallo Canna di Fucile (Cod.50)

**Bea High armchair (Cod.1000)** Leather/Fabric | Frame and piping: Nevada 2417 Cat.2000 - Seat and back cushions: One Col.00 Cat.D - Flair Collection - Legs | Gunmetal (Cod.50)

**Tavolino Picasso (Cod.9511)** Ripiano | marmo Dover White (Cod.DW) - Struttura | metallo Grigio Sabbia (Cod.56)

**Picasso coffee table (Cod.9511)** Top | Dover White marble (Cod.DW) - Structure | Sand Grey metal (Cod.56)



BRIC p.224-225

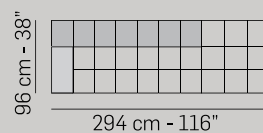

**Divano Bric (Cod.3002+8093)** Tessuto | Reg Col.38 Cat.G - Pure Velvet Collection

**Bric sofa (Cod.3002+8093)** Fabric | Reg Col.38 Cat.G - Pure Velvet Collection

**Cuscini** CU51 Tessuto | Reg Col.38 Cat.G - Pure Velvet Collection - CU52 Tessuto | Coc Col.01 Cat.G - Atelier Collection

**Pillows** CU51 Fabric | Reg Col.38 Cat.G - Pure Velvet Collection - CU52 Fabric | Coc Col.01 Cat.G - Atelier Collection



CADORNA p.126-127

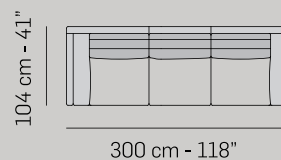

**Divano Cadorna (Cod.3580)** Pelle | Colorado 2551 Cat.2500 - Piedini | metallo Bronzo Anticato (Cod.52)

**Cadorna sofa (Cod.3580)** Leather | Colorado 2551 Cat.2500 - Legs | Antique Bronze metal (Cod.52)

**Cuscini** CU51 Tessuto | Dod Col.07 Cat.G - Tech Velvet Collection - CU51 Tessuto | Coc Col.00 Cat.G - Atelier Collection

**Pillows** CU51 Fabric | Dod Col.07 Cat.G - Tech Velvet Collection - CU51 Fabric | Coc Col.00 Cat.G - Atelier Collection

**Poltrona Fashion (Cod.1000)** Pelle/Tessuto | Scocca: Nevada 2415 Cat.2000 - Cuscini di seduta e spalliera: Leo Col.19 Cat.D - Flair Collection - Struttura | metallo Bronzo Anticato (Cod.52)

**Fashion armchair (Cod.1000)** Leather/Fabric | Frame: Nevada 2415 Cat.2000 - Seat and back cushions: Leo Col.19 Cat.D - Flair Collection - Structure | Antique Bronze metal (Cod.52)

**Tavolino Mondrian (Cod.9512)** Ripiano | marmo Onice Miele (Cod.OM) - Struttura | marmo Onice Miele (Cod.OM)

**Mondrian coffee table (Cod.9512)** Top | Onice Miele marble (Cod.OM) - Structure | Onice Miele marble (Cod.OM)

**Tavolino Matisse (Cod.9513)** Ripiano | marmo Dover White (Cod.DW) - Struttura | metallo Grigio Piombo (Cod.57)

**Matisse coffee table (Cod.9513)** Top | Dover White marble (Cod.DW) - Structure | Lead Grey metal (Cod.57)



CADORNA p.130-131

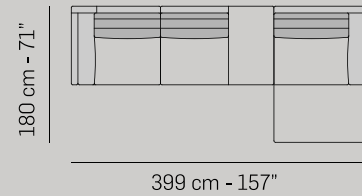

**Divano Cadorna (Cod.1202+1601+5301) (Cod.8099)** Tessuto | Mio Col.01 Cat.G - Atelier Collection - Piedini | metallo Canna di Fucile (Cod.50)

**Cadorna sofa (Cod.1202+1601+5301) (Cod.8099)** Fabric | Mio Col.01 Cat.G - Atelier Collection - Legs | Gunmetal (Cod.50)

**Cuscini CU51 n° 2** Tessuto | Reg Col.59 Cat.G - Pure Velvet Collection - CU51 Tessuto | Mio Col.01 Cat.G - Atelier Collection

**Pillows CU51 n° 2** Fabric | Reg Col.59 Cat.G - Pure Velvet Collection - CU51 Fabric | Mio Col.01 Cat.G - Atelier Collection

**Poltrona Bea High (Cod.1000+8012)** Tessuto | Reg Col.59 Cat.G - Pure Velvet Collection - Piede | metallo Bronzo Anticato (Cod.52)

**Bea High armchair (Cod.1000+8012)** Fabric | Reg Col.59 Cat.G - Pure Velvet Collection - Legs | Antique Bronze metal (Cod.52)

**Tavolino Metrico (Cod.9502)** Ripiano | marmo Nero Marquinia (Cod. NM) - Struttura | metallo Canna di Fucile (Cod.50)

**Metrico coffee table (Cod.9502)** Top | Black Marquinia marble (Cod. NM) - Structure | Gunmetal (Cod.50)

**Tavolino Metrico Small (Cod.9502)** Top | marmo Emperador (Cod.EM) - Struttura | metallo Bronzo Anticato (Cod.52)

**Metrico Small coffee table (Cod.9502)** Top | Emperador marble (Cod. EM) - Structure | Antique Bronze metal (Cod.52)



CAIROLI DEEP p.152-153

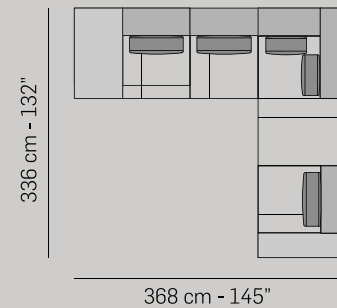

**Divano Cairoli Deep (Cod.D1922+D1203+D4004+D3231)** Tessuto | Dod Col.18 Cat.G - Tech Velvet Collection

**Cairoli Deep sofa (Cod.D1922+D1203+D4004+D3231)** Fabric | Dod Col.18 Cat.G - Tech Velvet Collection

**Poltrona Madeleine Swivel (Cod.1390)** Pelle | Diamond 4171 Cat.4000 - Base girevole | Legno finitura nero

**Madeleine Swivel armchair (Cod.1390)** Leather | Diamond 4171 Cat.4000 - Swivel base | Wooden base in black color

**Tavolino Matisse (Cod.9512)** Ripiano | marmo Quarzite Charme (Cod. QC) - Struttura | metallo Grigio Sabbia (Cod.56)

**Matisse coffee table (Cod.9512)** Top | Quarzite Charme marble (Cod. QC) - Structure | Sand Grey metal (Cod.56)

**Tavolino Matisse (Cod.9511)** Ripiano | marmo Patagonia (Cod.PA) - Struttura | metallo Ral (Cod.1013)

**Matisse coffee table (Cod.9511)** Top | Patagonia marble (Cod.PA) - Structure | metal Ral (Cod.1013)



**Divano Cairoli (Cod.1922+6031+1203)** Pelle | Colorado 2566 Cat.2500

**Cuscini** CU51 Tessuto | Coc Col.01 Cat.G - Atelier Collection - CU52 Pelle | Colorado 2566 Cat.2500

**Tavolino Botero (Cod.9511)** Ripiano | marmo Calacatta Bluette (Cod.CB) - Struttura | marmo Calacatta Bluette (Cod.CB)

**Tavolino Dalí (Cod.9511)** Ripiano | marmo Verde Alpi (VA) - Struttura | metallo Grigio Piombo (Cod.57)

## CAIROLI p.156-157

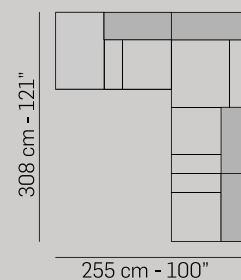

**Cairoli sofa (Cod.1922+6031+1203)** Leather | Colorado 2566 Cat.2500

**Pillows** CU51 Fabric | Coc Col.01 Cat.G - Atelier Collection - CU52 Leather | Colorado 2566 Cat.2500

**Botero coffee table (Cod.9511)** Top | Calacatta Bluette marble (Cod.CB) - Structure | Calacatta Bluette marble (Cod.CB)

**Dalí coffee table (Cod.9511)** Top | Verde Alpi marble (VA) - Structure | Lead grey metal (Cod.57)



**Divano Cairoli (Cod.1203+6031+1922)** Pelle | Colorado 2554 Cat.2500

**Pouf Cairoli (Cod.8098)** Tessuto | Coc Col.01 Cat.G - Atelier Collection

**Cuscini** CU52 Pelle | Colorado 2554 Cat.2500 - CU51 Tessuto | Coc Col.01 Cat.G - Atelier Collection - CU81 Tessuto | Coc Col.01 Cat.G - Atelier Collection

**Poltrona Gioia (Cod.1000)** Pelle/Tessuto | Mantellina: Colorado 2552 Cat.2500 - Cuscini di seduta e spalliera: Kos Col.01 Cat.D - Flair Collection - Struttura | metallo Bronzo Anticato (Cod.52)

**Tavolino Mondrian (Cod.9512)** Ripiano | marmo Onice Miele (Cod.OM) - Struttura | marmo Onice Miele (Cod.OM)

**Tavolino Monet (Cod.9511)** Ripiano | marmo Blu Roma (Cod.BR) - Struttura | metallo Grigio Sabbia (Cod.56)

## CAIROLI p.158-159

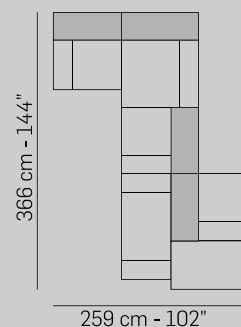

**Cairoli sofa (Cod.1203+6031+1922)** Leather | Colorado 2554 Cat.2500

**Cairoli footstool (Cod.8098)** Fabric | Coc Col.01 Cat.G - Atelier Collection

**Pillows** CU52 Leather | Colorado 2554 Cat.2500 - CU51 Fabric | Coc Col.01 Cat.G - Atelier Collection - CU81 Fabric | Coc Col.01 Cat.G - Atelier Collection

**Gioia armchair (Cod.1000)** Leather/Fabric | External mantle: Colorado 2552 Cat.2500 - Seat and back cushions: Kos Col.01 Cat.D - Flair Collection - Structure | Antique Bronze metal (Cod.52)

**Mondrian coffee table (Cod.9512)** Top | Onice Miele marble (Cod.OM) - Structure | Onice Miele marble (Cod.OM)

**Monet coffee table (Cod.9511)** Top | Blu Roma marble (Cod.BR) - Structure | Sand Grey metal (Cod.56)



**Divano Cairoli e Cairoli Deep (Cod.D3202+1921)** Tessuto | Imi Col.01 Cat.G - Atelier Collection

**Cuscini** CU57 Tessuto | Reg Col.46 Cat.G - Pure Velvet Collection - CU57 Tessuto | Reg Col.70 Cat.G - Pure Velvet Collection

**Poltrona Proust (Cod.1000)** Pelle/Tessuto | Scocca: Nabuk 5009 Cat.5000 - Cuscini di seduta e spalliera: Olo Col.01 Cat.G - Atelier Collection - Piede | metallo Canna di Fucile (Cod.50)

**Tavolino Picasso (Cod.9511)** Ripiano | marmo Blu Roma (Cod.BR) - Struttura | metallo Grigio Sabbia (Cod.56)

## CAIROLI DEEP - CAIROLI p.148-149

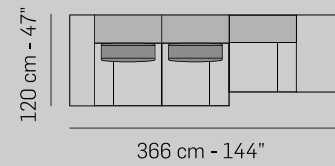

**Cairoli and Cairoli Deep sofa (Cod.D3202+1921)** Fabric | Imi Col.01 Cat.G - Atelier Collection

**Pillows** CU57 Fabric | Reg Col.46 Cat.G - Pure Velvet Collection - CU57 Fabric | Reg Col.70 Cat.G - Pure Velvet Collection

**Proust armchair (Cod.1000)** Leather/Fabric | Frame: Nabuk 5009 Cat.5000 - Seat and back cushions: Olo Col.01 Cat.G - Atelier Collection - Legs | Gunmetal (Cod.50)

**Picasso coffee table (Cod.9511)** Top | Blu Roma marble (Cod.BR) - Structure | Sand Grey metal (Cod.56)



**Divano Crumble (Cod.1202+3441)** Tessuto | Reg Col.34 Cat.G - Pure Velvet Collection - Piedini | metallo Canna di Fucile (Cod.50)

**Cuscino** CU51 Tessuto | Reg Col.59 Cat.G - Pure Velvet Collection

**Poltrona Soufflé (Cod.1000)** n° 2 Tessuto | Coc Col.12 Cat.G - Atelier Collection - Piede e bottone | metallo Canna di Fucile (Cod.50)

**Tavolino Picasso (Cod.9511)** Ripiano | marmo Blu Roma (Cod.BR) - Struttura | metallo Grigio Sabbia (Cod.56)

## CRUMBLE p.14-15

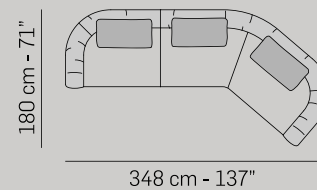

**Crumble sofa (Cod.1202+3441)** Fabric | Reg.34 Cat.G - Pure Velvet Collection - Legs | Gunmetal (Cod.50)

**Pillow** CU51 Fabric | Reg Col.59 Cat.G - Pure Velvet Collection

**Soufflé armchair (Cod.1000)** n° 2 Fabric | Coc Col.12 Cat.G - Atelier Collection - Legs and button | Gunmetal (Cod.50)

**Picasso coffee table (Cod.9511)** Top | Blu Roma marble (Cod.BR) - Structure | Sand Grey metal (Cod.56)



**Divano Crumble (Cod.3160)** Pelle | Colorado 2565 Cat.2500 - Piedini | metallo Ottone Satinato (Cod.51)

**Poltrona Nest (Cod.1000•8128)** Tessuto | Reg Col.62 Cat.G - Pure Velvet Collection - Piede | metallo Canna di Fucile (Cod.50)

**Tavolino Botero (Cod.9511)** n° 2 Ripiano | marmo Sasso Rosso (Cod. SR) - Struttura | marmo Sasso Rosso (Cod.SR)

## CRUMBLE p.18-19

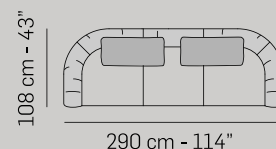

**Crumble sofa (Cod.3160)** Leather | Colorado 2565 Cat.2500 - Legs | Satin Brass metal (Cod.51)

**Nest armchair (Cod.1000•8128)** Fabric | Reg Col.62 Cat.G - Pure Velvet Collection - Legs | Gunmetal (Cod.50)

**Botero coffee table (Cod.9511)** n° 2 Top | Sasso Rosso marble (Cod. SR) - Structure | Sasso Rosso marble (Cod.SR)



**Divano Egeo (Cod.3022•4231)** Pelle | Colorado 2551 Cat.2500 - Piedini | metallo Bronzo Anticato (Cod.52)

**Cuscini CU51** Tessuto | Per Col.01 Cat.D - Flair Collection - CU81 Tessuto | Ica Col.07 Cat.G - Atelier Collection

**Poltrona Nest Swivel (Cod.1470)** Tessuto | Ica Col.07 Cat.G - Atelier Collection - Base girevole | metallo Bronzo Anticato (Cod.52)

**Tavolino Fly Small (Cod.9502)** Ripiano | metallo Bronzo Anticato (Cod.52) - Struttura | metallo Bronzo Anticato (Cod.52)

**Tavolino Grancircolo (Cod.9502)** Ripiano | marmo Nero Marquinia (Cod. NM) - Struttura | metallo Canna di Fucile (Cod.50)

**Tavolino Circolo (Cod.9502)** Ripiano | marmo Nero Marquinia (Cod. NM) - Struttura | metallo Canna di Fucile (Cod.50)

## EGEO p.228-229

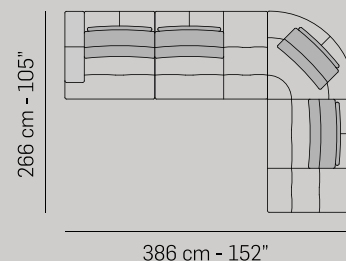

**Egeo sofa (Cod.3022•4231)** Leather | Colorado 2551 Cat.2500 - Legs | Antique Bronze metal (Cod.52)

**Pillows CU51** Fabric | Per Col.01 Cat.D - Flair Collection - CU81 Fabric | Ica Col.07 Cat.G - Atelier Collection

**Nest Swivel armchair (Cod.1470)** Fabric | Ica Col.07 Cat.G - Atelier Collection - Swivel base | Antique Bronze metal (Cod.52)

**Fly Small coffee table (Cod.9502)** Top | Antique Bronze metal (Cod.52) - Structure | Antique Bronze metal (Cod.52)

**Grancircolo coffee table (Cod.9502)** Top | Black Marquinia marble (Cod. NM) - Structure | Gunmetal (Cod.50)

**Circolo coffee table (Cod.9502)** Top | Black Marquinia marble (Cod. NM) - Structure | Gunmetal (Cod.50)



**Divano Egeo (Cod.5202\*3003\*3030)** Pelle | Colorado 2550 Cat.2500 - Piedini | metallo Bronzo Anticato (Cod.52)

**Cuscini** CU51 n° 2 Tessuto | Coc Col.00 Cat.G - Atelier Collection - CU51 Tessuto | Reg Col.70 Cat.G - Pure Velvet Collection

**Poltrona Fashion (Cod.1000)** Pelle/Tessuto | Scocca: Nevada 2415 Cat.2000 - Cuscini di seduta e spalliera: Leo Col.19 Cat.D - Flair Collection - Struttura | metallo Bronzo Anticato (Cod.52)

**Tavolino Mondrian (Cod.9511)** Ripiano | marmo Onice Miele (Cod.OM) - Struttura | marmo Onice Miele (Cod.OM)

**Tavolino Picasso (Cod.9512)** Ripiano | marmo Blu Roma (Cod.BR) - Struttura | metallo Grigio Sabbia (Cod.56)

EGEO p.234-235

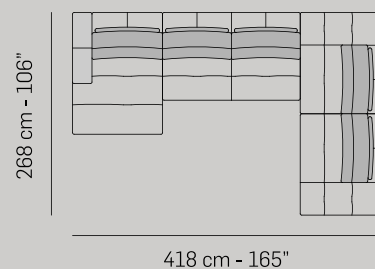

**Egeo sofa (Cod.5202\*3003\*3030)** Leather | Colorado 2550 Cat.2500 - Legs | Antique Bronze metal (Cod.52)

**Pillows** CU51 n° 2 FABric | Coc Col.00 Cat.G - Atelier Collection - CU51 Fabric | Reg Col.70 Cat.G - Pure Velvet Collection

**Fashion armchair (Cod.1000)** Leather/Fabric | Frame: Nevada 2415 Cat.2000 - Seat and back cushions: Leo Col.19 Cat.D - Flair Collection - Structure | Antique Bronze metal (Cod.52)

**Mondrian coffee table (Cod.9511)** Top | Onice Miele marble (Cod.OM) - Structure | Onice Miele marble (Cod.OM)

**Picasso coffee table (Cod.9512)** Top | Blu Roma marble (Cod.BR) - Structure | Sand Grey metal (Cod.56)



EGEO p.238

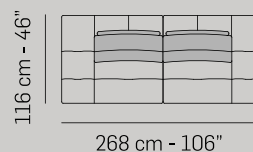

**Divano Egeo (Cod.3030)** Pelle | Colorado 2550 Cat.2500 - Piedini | metallo Bronzo Anticato (Cod.52)

**Cuscino** CU51 Tessuto | Coc Col.00 Cat.G - Atelier Collection

**Tavolino Plane (Cod.9502)** Ripiano | marmo Bianco Carrara (Cod.CA) - Struttura | metallo Canna di Fucile (Cod.50)

**Tavolino Picasso (Cod.9511)** Ripiano | marmo Blu Roma (Cod.BR) - Struttura | metallo Grigio Sabbia (Cod.56)

**Egeo sofa (Cod.3030)** Leather | Colorado 2550 Cat.2500 - Legs | Antique Bronze metal (Cod.52)

**Pillow** CU51 Fabric | Coc Col.00 Cat.G - Atelier Collection

**Plane coffee table (Cod.9502)** Top | White Carrara marble (Cod.CA) - Structure | Gunmetal (Cod.50)

**Picasso coffee table (Cod.9511)** Top | Blu Roma marble (Cod.BR) - Structure | Sand Grey metal (Cod.56)





GARY p.58-59

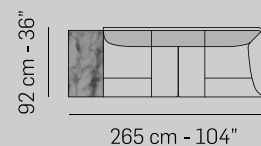

**Divano Gary (Cod.3521)** Tessuto | Reg Col.06 Cat.G - Pure Velvet Collection - Piedini | metallo Ottone Satinato (Cod.51) - Ripiano | marmo Bianco Carrara (Cod.CA)

**Gary sofa (Cod.3521)** Fabric | Reg Col.06 Cat.G - Pure Velvet Collection - Legs | Satin Brass metal (Cod.51) - Top | White Carrara marble (Cod.CA)

**Cuscino** CU51 Tessuto | Reg Col.06 Cat.G - Pure Velvet Collection

**Pillow** CU51 Fabric | Reg Col.06 Cat.G - Pure Velvet Collection



GARY p.62-63

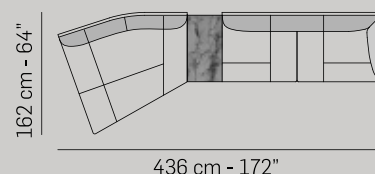

**Divano Gary (Cod.2012+3521)** Tessuto | Reg Col.06 Cat.G - Pure Velvet Collection - Piedini | metallo Ottone Satinato (Cod.51) - Ripiano | marmo Bianco Carrara (Cod.CA)

**Gary sofa (Cod.2012+3521)** Fabric | Reg Col.06 Cat.G - Pure Velvet Collection - Legs | Satin Brass metal (Cod.51) - Top | White Carrara marble (Cod.CA)

**Cuscini** CU51 n° 2 Tessuto | Reg Col.06 Cat.G - Pure Velvet Collection - CU51 Tessuto | Por Col.26 Cat.G - Atelier Collection

**Pillows** CU51 n° 2 Fabric | Reg Col.06 Cat.G - Pure Velvet Collection - CU51 Fabric | Por Col.26 Cat.G - Atelier Collection

**Poltrona Diga (Cod.1000)** Pelle/Tessuto | Scocca, passanti e bordino: Royal 2367 Cat.2000 - Cuscini di seduta e spalliera: Mem Col.01 Cat.G - Atelier Collection - Piede | metallo Canna di Fucile (Cod.50) con parte inferiore verniciata in Oro Satinato

**Diga armchair (Cod.1000)** Leather/Fabric | Frame, piping and belt loops: Royal 2367 Cat.2000 - Seat and back cushions: Mem Col.01 Cat.G - Atelier Collection - Legs | Gunmetal (Cod.50) with lower part painted in Matte Gold color

**Pouf Dot (Cod.8020)** Tessuto | Por Col.26 Cat.G - Atelier Collection

**Dot footstool (Cod.8020)** Fabric | Por Col.26 Cat.G - Atelier Collection

**Tavolino Grancircolo (Cod.9502)** Ripiano | marmo Nero Maquinia (Cod. NM) - Struttura | metallo Canna di Fucile (Cod.50)

**Grancircolo coffee table (Cod.9502)** Top | Black Marquinia marble (Cod. NM) - Structure | Gunmetal (Cod.50)



**Divano Nausicaa (Cod.3002•2221)** Tessuto | Olo Col.01 Cat.G - Atelier Collection - Piedini | metallo Canna di Fucile (Cod.50)

**Cuscini** CU51 n° 2 Tessuto | Olo Col.01 Cat.G - Atelier Collection - CU57 Tessuto | Reg Col.70 Cat.G - Pure Velvet Collection - CU51 Tessuto | Mem Col.06 Cat.G - Atelier Collection

**Poltrona Rondò (Cod.1000)** Tessuto | Dod Col.07 Cat.G - Tech Velvet Collection - Piede | Legno finitura Wengé (Cod.05)

**Tavolino Mondrian (Cod.9512)** Ripiano | marmo Onice Miele (Cod.OM) - Struttura | marmo Onice Miele (Cod.OM)

**Tavolino Matisse (Cod.9511)** Ripiano | marmo Nero Marquinia (Cod. NM) - Struttura | metallo Grigio Piombo (Cod.57)

## NAUSICAA p.196-197

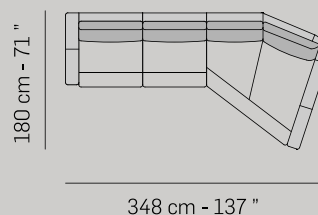

**Nausicaa sofa (Cod.3002•2221)** Fabric | Olo Col.01 Cat.G - Atelier Collection - Legs | Gunmetal (Cod.50)

**Pillows** CU51 n° 2 Fabric | Olo Col.01 Cat.G - Atelier Collection - CU57 Fabric | Reg Col.70 Cat.G - Pure Velvet Collection - CU51 Fabric | Mem Col.06 Cat.G - Atelier Collection

**Rondò armchair (Cod.1000)** Fabric | Dod Col.07 Cat.G - Tech Velvet Collection - Legs | Wooden legs in Wengé (Cod.05)

**Mondrian coffee table (Cod.9512)** Top | Onice Miele marble (Cod.OM) - Structure | Onice Miele marble (Cod.OM)

**Matisse coffee table (Cod.9511)** Top | Black Marquinia marble (Cod. NM) - Structure | Lead Grey marble (Cod.57)



**Divano Pacific Square (Cod.3022)** Pelle | Colorado 2566 Cat.2500 - Piedini | metallo Bronzo Anticato (Cod.52)

**Cuscino** CU51 Tessuto | Imi Col.01 Cat.G - Atelier Collection

**Tavolino Dalí (Cod.9511)** Ripiano | marmo Sasso Rosso (Cod.SR) - Struttura | metallo Titanio (Cod.58)

## PACIFIC SQUARE p.202

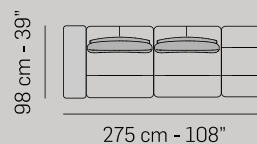

**Divano Pacific Square (Cod.3022)** Leather | Colorado 2566 Cat.2500 - Legs | Antique Bronze metal (Cod.52)

**Cuscino** CU51 Fabric | Imi Col.01 Cat.G - Atelier Collection

**Dali coffee table (Cod.9511)** Top | Sasso Rosso marble (Cod.SR) - Structure | Titanium metal (Cod.58)



**Divano Pacific Square (Cod.3022•4231)** Pelle | Colorado 2565 Cat.2500 - Piedini | metallo Bronzo Anticato (Cod.52)

**Cuscini** CU51 n° 2 Tessuto | Imi Col.01 Cat.G - Atelier Collection - CU51 Tessuto | Dod Col.18 Cat.G - Tech Velvet Collection

**Poltrona Rho (Cod.1000)** Tessuto | Imi Col.01 Cat.G - Atelier Collection - Struttura | metallo Canna di Fucile (Cod.50)

**Tavolino Metrico (Cod.9502)** Ripiano | marmo Nero Marquinia (Cod. NM) - Struttura | metallo Canna di Fucile (Cod.50)

**Tavolino Plane (Cod.9502)** Ripiano | marmo Bianco Carrara (Cod.CA) - Struttura | metallo Canna di Fucile (Cod.50)

**Tavolino Circolo (Cod.9502)** Ripiano | marmo Nero Marquinia (Cod. NM) - Struttura | metallo Canna di Fucile (Cod.50)

**Tavolino Shiny (Cod.9502)** Ripiano | metallo Ottone Satinato (Cod.51) - Struttura | metallo Ottone Satinato (Cod.51)

## PACIFIC SQUARE p.204-205

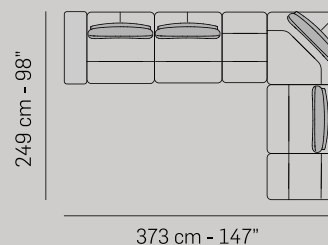

**Pacific Square sofa (Cod.3022•4231)** Leather | Colorado 2565 Cat.2500 - Legs | Antique Bronze metal (Cod.52)

**Pillows** CU51 n° 2 Fabric | Imi Col.01 Cat.G - Atelier Collection - CU51 Fabric | Dod Col.18 Cat.G - Tech Velvet Collection

**Rho armchair (Cod.1000)** Fabric | Imi Col.01 Cat.G - Atelier Collection - Structure | Gunmetal (Cod.50)

**Metrico coffee table (Cod.9502)** Top | Black Marquinia marble (Cod. NM) - Structure | Gunmetal (Cod.50)

**Plane coffee table (Cod.9502)** Top | White Carrara marble (Cod.CA) - Structure | Gunmetal (Cod.50)

**Circolo coffee table (Cod.9502)** Top | Black Marquinia marble (Cod. NM) - Structure | Gunmetal (Cod.50)

**Shiny coffee table (Cod.9502)** Top | Satin Brass metal (Cod.51) - Structure | Satin Brass metal (Cod.51)



## PACIFIC SQUARE p.210-211

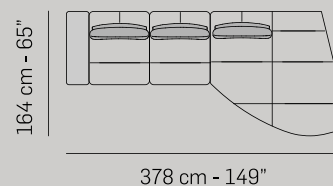

**Divano Pacific Square (Cod.2202•5061)** Pelle | Royal 2367 Cat.2000 - Piedini | metallo Bronzo Anticato (Cod.52)

**Cuscini** CU51 n° 2 Tessuto | Coc Col.00 Cat.G - Atelier Collection - CU51 Tessuto | Reg Col.34 Cat.G - Pure Velvet Collection

**Poltrona Proust (Cod.1000)** Pelle/Tessuto | Scocca: Nabuk 5009 Cat.5000 - Cuscini di seduta e spalliera: Olo Col.01 Cat.G - Atelier Collection - Piede | metallo Canna di Fucile (Cod.50)

**Tavolino Matisse (Cod.9513)** Ripiano | marmo Dover White (Cod.DW) - Struttura | metallo Grigio Piombo (Cod.57)

**Tavolino Plane (Cod.9502)** Ripiano | marmo Bianco Carrara (Cod.CA) - Struttura | metallo Canna di Fucile (Cod.50)

**Pacific Square sofa (Cod.2202•5061)** Leather | Royal 2367 Cat.2000 - Legs | Antique Bronze metal (Cod.52)

**Pillows** CU51 n° 2 Fabric | Coc Col.00 Cat.G - Atelier Collection - CU51 Fabric | Reg Col.34 Cat.G - Pure Velvet Collection

**Proust armchair (Cod.1000)** Leather/Fabric | Frame: Nabuk 5009 Cat.5000 - Seat and back cushions: Olo Col.01 Cat.G - Atelier Collection - Legs | Gunmetal (Cod.50)

**Matisse coffee table (Cod.9513)** Top | Dover White marble (Cod.DW) - Structure | Lead Grey metal (Cod.57)

**Plane coffee table (Cod.9502)** Top | White Carrara marble (Cod.CA) - Structure | Gunmetal (Cod.50)



**Divano Penta (Cod.3900)** n° 2 Tessuto | Lir Col.77 Cat.D - Flair Collection - Piedini (optional) | metallo Ottone Satinato (Cod.51)

**Tavolino Picasso (Cod.9511)** Ripiano | marmo Dover White (Cod.DW) - Struttura | metallo Grigio Sabbia (Cod.56)

## PENTA p.166-167

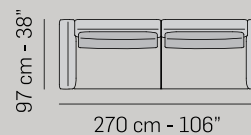

**Penta sofa (Cod.3900)** n° 2 Fabric | Lir Col.77 Cat.D - Flair Collection - Legs (optional) | Satin Brass metal (Cod.51)

**Picasso coffee table (Cod.9511)** Top | Dover White marble (Cod.DW) - Structure | Sand Grey metal (Cod.56)



**Divano Penta (Cod.3202+4231)** Tessuto | Ica Col.18 Cat.G - Atelier Collection - Piedini | metallo Bronzo Anticato (Cod.52)

**Cuscino CU51** Tessuto | Reg Col.33 Cat.G - Pure Velvet Collection

**Poltrona Nicole (Cod.1000)** Pelle | Nabuk 5009 Cat.5000 - Bordino | Ecopelle siliconica Col.4121 - Struttura | metallo Ottone Brunito (Cod.54)

**Tavolino Dalí (Cod.9511)** Ripiano | marmo Nero Marquinia (Cod.NM) - Struttura | metallo Grigio Sabbia (Cod.56)

**Tavolino Botero (Cod.9512)** Ripiano | marmo Verde Alpi (Cod.VA) - Struttura | marmo Verde Alpi (Cod.VA)

## PENTA p.170-171

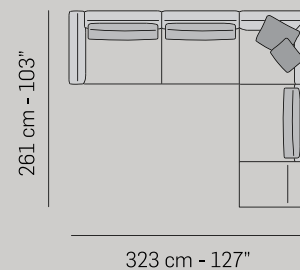

**Penta sofa (Cod.3202+4231)** Fabric | Ica Col.18 Cat.G - Atelier Collection - Legs | Antique Bronze metal (Cod.52)

**Pillow CU51** Fabric | Reg Col.33 Cat.G - Pure Velvet Collection

**Nicole armchair (Cod.1000)** Leather | Nabuk 5009 Cat.5000 - Piping | Eco-leather Col.4121 - Structure | Burnished Brass metal (Cod.54)

**Dalí coffee table (Cod.9511)** Top | Black Marquinia marble (Cod.NM) - Structure | Sand Grey metal (Cod.56)

**Botero coffee table (Cod.9512)** Top | Verde Alpi marble (Cod.VA) - Structure | Verde Alpi marble (Cod.VA)



**Divano Play (Cod.3202+4024+1631)** Pelle | Nevada 2415 Cat.2000

**Cuscini** CU51 n° 2 Tessuto | Por Col.26 Cat.G - Atelier Collection

**Poltrona Fashion (Cod.1000)** Tessuto | Reg Col.62 Cat.G - Pure Velvet Collection - Struttura | metallo Canna di Fucile (Cod.50)

**Tavolino Metrico (Cod.9502)** Ripiano | marmo Sequoia Grey (Cod.SG) - Struttura | metallo Canna di Fucile (Cod.50)

**Tavolino Shiny (Cod.9502)** Ripiano | metallo Ottone Satinato (Cod.51) - Struttura | metallo Ottone Satinato (Cod.51)

PLAY p.110-111

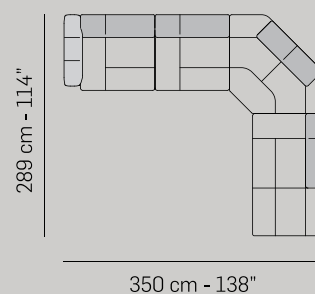

**Play sofa (Cod.3202+4024+1631)** Leather | Nevada 2415 Cat.2000

**Pillows** CU51 n° 2 Fabric | Por Col.26 Cat.G - Atelier Collection

**Fashion armchair (Cod.1000)** Fabric | Reg Col.62 Cat.G - Pure Velvet Collection - Structure | Gunmetal (Cod.50)

**Metrico coffee table (Cod.9502)** Top | Sequoia Grey marble (Cod.SG) - Structure | Gunmetal (Cod.50)

**Shiny coffee table (Cod.9502)** Top | Satin Brass metal (Cod.51) - Structure | Satin Brass metal (Cod.51)



**Divano Play (Cod.3202+1631)** Pelle | Nevada 2415 Cat.2000

**Cuscini** CU81 Tessuto | Por Col.11 Cat.G - Atelier Collection - CU51 Tessuto | Por Col.25 Cat.G - Atelier Collection

**Poltrona Nicole (Cod.1000)** Pelle/Tessuto | Interno: Diamond 4164 Cat.4000 - Esterno: Mio Col.01 Cat.G - Atelier Collection - Bordino | Ecopelle siliconica Col.4006 - Struttura | metallo Ottone Brunito (Cod.54)

**Tavolino Circolo (Cod.9502)** Ripiano | marmo Nero Marquinia (Cod. NM) - Struttura | metallo Canna di Fucile (Cod.50)

**Tavolino Grancircolo (Cod.9502)** Ripiano | marmo Nero Marquinia (Cod. NM) - Struttura | metallo Canna di Fucile (Cod.50)

**Tavolino Round (Cod.9502)** Ripiano | marmo Bianco Carrara (Cod.CA) - Struttura | metallo Canna di Fucile (Cod.50)

PLAY p.114-115

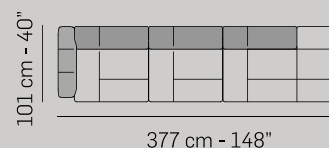

**Play sofa (Cod.3202+1631)** Leather | Nevada 2415 Cat.2000

**Pillows** CU81 Fabric | Por Col.11 Cat.G - Atelier Collection - CU51 Fabric | Por Col.25 Cat.G - Atelier Collection

**Nicole armchair (Cod.1000)** Leather/Fabric | Inside: Diamond 4164 Cat.4000 - Outside: Mio Col.01 Cat.G - Atelier Collection - Piping | Eco-leather Col.4006 - Structure | Burnished Brass metal (Cod.54)

**Circolo coffee table (Cod.9502)** Top | Black Marquinia marble (Cod. NM) - Structure | Gunmetal (Cod.50)

**Grancircolo coffee table (Cod.9502)** Top | Black Marquinia marble (Cod. NM) - Structure | Gunmetal (Cod.50)

**Round coffee table (Cod.9502)** Top | White Carrara marble (Cod.CA) - Structure | Gunmetal (Cod.50)



PLAY p.118-119

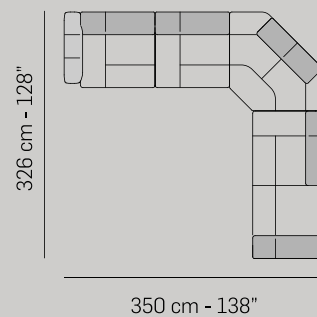

**Divano Play (Cod.3202+4024+6031)** Pelle | Colorado 2550 Cat.2500

**Cuscino** CU52 Pelle | Colorado 2550 Cat.2500

**Pouf Main (Cod.8015)** Tessuto | Reg Col.34 Cat.G - Pure Velvet Collection

**Tavolino Botero (Cod.9511)** n° 2 Ripiano | marmo Breccia Croata (Cod. BC) - Struttura | marmo Breccia Croata (Cod.BC)

**Play sofa (Cod.3202+4024+6031)** Leather | Colorado 2550 Cat.2500

**Pillow** CU52 Leather | Colorado 2550 Cat.2500

**Main footstool (Cod.8015)** Fabric | Reg Col.34 Cat.G - Pure Velvet Collection

**Botero coffee table (Cod.9511)** n° 2 Top | Breccia Croata marble (Cod. BC) - Structure | Breccia Croata marble (Cod.BC)



STRAUSS p.68-69

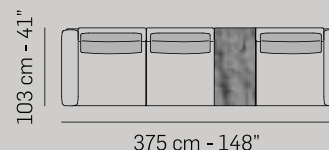

**Divano Strauss (Cod.3032+1201)** Pelle | Royal 2367 Cat.2000 - Piedini | metallo Ottone Satinato (Cod.51) - Ripiano | marmo Sequoia Grey (Cod.SG)

**Cuscino** CU51 Tessuto | Por Col.25 Cat.G - Atelier Collection

**Poltrona Nicole (Cod.1000)** Pelle/Tessuto | Interno: Diamond 4164 Cat.4000 - Esterno: Mio Col.01 Cat.G - Atelier Collection - Bordino | Ecopelle siliconica Col.4006 - Struttura | metallo Ottone Brunito (Cod.54)

**Tavolino Grancircolo (Cod.9502)** Ripiano | marmo Nero Marquinia (Cod. NM) - Struttura | metallo Canna di Fucile (Cod.50)

**Strauss sofa (Cod.3032+1201)** Leather | Royal 2367 Cat.2000 - Legs | Satin Brass metal (Cod.51) - Top | Sequoia Grey marble (Cod.SG)

**Pillow** CU51 Fabric | Por Col.25 Cat.G - Atelier Collection

**Nicole armchair (Cod.1000)** Leather/Fabric | Inside: Diamond 4164 Cat.4000 - Outside: Mio Col.01 Cat.G - Atelier Collection - Piping | Eco-leather Col.4006 - Structure | Burnished Brass metal (Cod.54)

**Grancircolo coffee table (Cod.9502)** Top | Black Marquinia marble (Cod. NM) - Structure | Gunmetal (Cod.50)



**Divano Strauss (Cod.3002+1601)** Pelle/Tessuto | Basetta: Diamond 4164 Cat.4000 - Cuscinatura: Olo Col.01 Cat.G - Atelier Collection - Piedini | metallo Bronzo Anticato (Cod.52)

**Cuscino** CU51 Tessuto | Olo Col.01 Cat.G - Atelier Collection

**Tavolino Matisse (Cod.9512)** Ripiano | marmo Quarzite Charme (Cod. QC) - Struttura | metallo Grigio Sabbia (Cod.56)

**Tavolino Dalí (Cod.9511)** Ripiano | marmo Sasso Rosso (Cod.SR) - Struttura | metallo Titanio (Cod.58)

## STRAUSS p.70-71

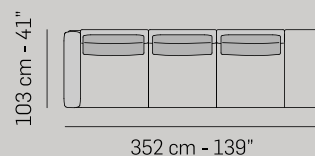

**Strauss sofa (Cod.3002+1601)** Leather/Fabric | Base: Diamond 4164 Cat.4000 - Back and seat cushions, armrest: Olo Col.01 Cat.G - Atelier Collection - Legs | Antique Bronze metal (Cod.52)

**Pillow** CU51 Fabric | Olo Col.01 Cat.G - Atelier Collection

**Matisse coffee table (Cod.9512)** Top | Quarzite Charme marble (Cod. QC) - Structure | Sand Grey metal (Cod.56)

**Dalí coffee table (Cod.9511)** Top | Sasso Rosso marble (Cod.SR) - Structure | Titanium metal (Cod.58)



**Divano Strauss (Cod.3002+4024+1601)** Pelle/Tessuto | Basetta: Diamond 4164 Cat.4000 - Cuscinatura: Olo Col.01 Cat.G - Atelier Collection - Piedini | Bronzo Anticato (Cod.52)

**Cuscino** CU51 Tessuto | Dod Col.18 Cat.G - Tech Velvet Collection

**Poltrona Dia (Cod.1000)** Tessuto | Per Col.19 Cat.D - Flair Collection - Piede | metallo Canna di Fucile (Cod.50)

**Tavolino Monet (Cod.9511+9512)** Ripiano | marmo Verde Alpi (Cod.VA) - Struttura | metallo Titanio (Cod.58)

## STRAUSS p.74-75

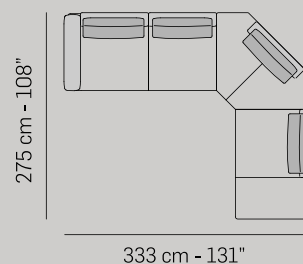

**Strauss sofa (Cod.3002+4024+1601)** Leather/Fabric | Base: Diamond 4164 Cat.4000 - Back and seat cushions, armrest: Olo Col.01 Cat.G - Atelier Collection - Legs | Antique Bronze (Cod.52)

**Pillow** CU51 Fabric | Dod Col.18 Cat.G - Tech Velvet Collection

**Dia armchair (Cod.1000)** Fabric | Per Col.19 Cat.D - Flair Collection - Legs | Gunmetal (Cod.50)

**Monet coffee table (Cod.9511+9512)** Top | Verde Alpi marble (Cod. VA) - Structure | Titanium metal (Cod.58)



## STRAUSS p.76-77

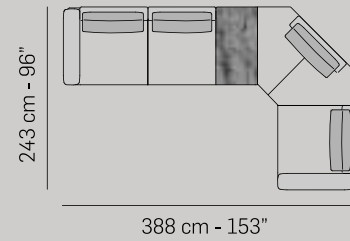

**Divano Strauss (Cod.3032+4024+1201)** Pelle | Royal 2367 Cat.2000 - Piedini | metallo Ottone Satinato (Cod.51) - Ripiano | marmo Sequoia Grey (Cod.SG)

**Poltrona Lady Swivel (Cod.1360)** Tessuto | Por Col.26 Cat.G - Atelier Collection - Base girevole | Legno finitura nero

**Tavolino Metrico (Cod.9502)** n° 2 Ripiano | marmo Sequoia Grey (Cod. SG) - Struttura | metallo Canna di Fucile (Cod.50)

**Strauss sofa (Cod.3032+4024+1201)** Leather | Royal 2367 Cat.2000 - Legs | Satin Brass metal (Cod.51) - Top | Sequoia Grey marble (Cod.SG)

**Lady Swivel armchair (Cod.1360)** Fabric | Por Col.26 Cat.G - Atelier Collection - Swivel base | Wooden base in black color

**Metrico coffee table (Cod.9502)** n° 2 Top | Sequoia Grey marble (Cod. SG) - Structure | Gunmetal (Cod.50)



## ZARA DEEP p.176-177

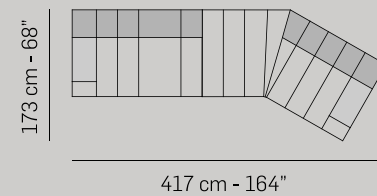

**Divano Zara Deep (Cod.D2202+D1091)** Tessuto | Por Col.04 Cat.G - Atelier Collection - Piedini | Nero laccato lucido (Cod.27)

**Cuscini CU51** Tessuto | Por Col.04 Cat.G - Atelier Collection - CU51 Tessuto | Por Col.26 Cat.G - Atelier Collection - CU81 Tessuto | Por Col.04 Cat.G - Atelier Collection

**Tavolino Botero (Cod.9511)** n° 2 Ripiano | marmo Breccia Croata (Cod. BC) - Struttura | marmo Breccia Croata (Cod.BC)

**Zara sofa (Cod.D2202+D1091)** Fabric | Por Col.04 Cat.G - Atelier Collection - Legs | Wooden legs in black gloss lacquered (Cod.27)

**Pillows CU51** Fabric | Por Col.04 Cat.G - Atelier Collection - CU51 Fabric | Por Col.26 Cat.G - Atelier Collection - CU81 Fabric | Por Col.04 Cat.G - Atelier Collection

**Botero coffee table (Cod.9511)** n° 2 Top | Breccia Croata marble (Cod. BC) - Structure | Breccia Croata marble (Cod.BC)





**Divano Zara Deep (Cod.D1091)** Tessuto | Por Col.06 Cat.G - Atelier Collection - Piedini | Nero laccato lucido (Cod.27)

**Cuscino** CU81 Tessuto | Por Col.06 Cat.G - Atelier Collection

**Tavolino Dalí (Cod.9511)** Ripiano | marmo Verde Alpi (Cod.VA) - Struttura | metallo Grigio Piombo (Cod.57)

**Tavolino Renoir (Cod.9514)** Ripiano | marmo Quarzite Charme (Cod.QC) - Struttura | metallo Grigio Sabbia (Cod.56)

## ZARA DEEP p.180-181

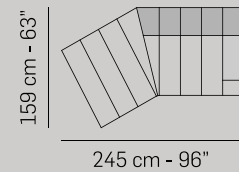

**Zara Deep sofa (Cod.D1091)** Fabric | Por Col.06 Cat.G - Atelier Collection - Legs | Wooden legs in black gloss lacquered (Cod.27)

**Pillow** CU81 Fabric | Por Col.06 Cat.G - Atelier Collection

**Dalí coffee table (Cod.9511)** Top | Verde Alpi marble (Cod.VA) - Structure | Lead Grey metal (Cod.57)

**Renoir coffee table (Cod.9514)** Top | Quarzite Charme marble (Cod.QC) - Structure | Sand Grey metal (Cod.56)



**Divano Zara e Zara Deep (Cod.3002•D1091)**  
(Cod.3002) Pelle | Nevada 2415 Cat.2000 - Piedini | Nero laccato lucido (Cod.27)

(Cod.D1091) Tessuto | Por Col.16 Cat.G - Atelier Collection - Piedini | Nero laccato lucido (Cod.27)

**Cuscini** CU51 n° 2 Tessuto | Por Col.26 Cat.G - Atelier Collection - CU51 Tessuto | Reg Col.53 Cat.G - Pure Velvet Collection

**Tavolino Circolo (Cod.9502)** Ripiano | marmo Nero Marquinia (Cod.NM) - Struttura | metallo Canna di Fucile (Cod.50)

**Tavolino Round (Cod.9502)** Ripiano | marmo Bianco Carrara (Cod.CA) - Struttura | metallo Canna di Fucile (Cod.50)

## ZARA - ZARA DEEP p.184-185

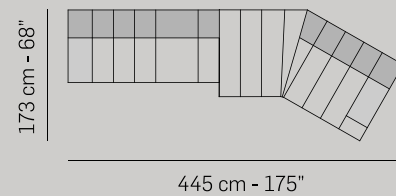

**Zara e Zara Deep sofa (Cod.3002•D1091)**  
(Cod.3002) Leather | Nevada 2415 Cat.2000 - Legs | Wooden legs in black gloss lacquered (Cod.27)

(Cod.D1091) Fabric | Por Col.16 Cat.G - Atelier Collection - Legs | Wooden legs in black gloss lacquered (Cod.27)

**Pillows** CU51 n° 2 Fabric | Por Col.26 Cat.G - Atelier Collection - CU51 Fabric | Reg Col.53 Cat.G - Pure Velvet Collection

**Circolo coffee table (Cod.9502)** Top | Black Marquinia marble (Cod.NM) - Structure | Gunmetal (Cod.50)

**Tavolino Round (Cod.9502)** Top | White Carrara marble (Cod.CA) - Structure | Gunmetal (Cod.50)



**Divano Zara e Zara Light (Cod.3002+L2201) (Cod.6033+6033)**  
**(Cod.3002)** Pelle | Nevada 2415 Cat.2000 - Piedini | Nero laccato lucido (Cod.27)  
**(Cod.L2201+6033)** Tessuto | Amo Col.08 Cat.G - Atelier Collection -  
 Bracciolo: Nevada 2415 Cat.2000 - Piedini | Nero laccato lucido (Cod.27)

**Cuscini** CU51 n° 2 Tessuto | Amo Col.08 Cat.G - Atelier Collection -  
 CU81 Tessuto | Amo Col.08 Cat.G - Atelier Collection -  
 CU51 n° 2 Tessuto | Dod Col.18 Cat.G - Tech Velvet Collection

**Tavolino Monet (Cod.9511+9512)** Ripiano | marmo Verde Alpi (Cod.VA) -  
 Struttura | metallo Titanio (Cod.58)

**Tavolino Mondrian (Cod.9511)** Ripiano | marmo Verde Alpi (Cod.VA) -  
 Struttura | marmo Verde Alpi (Cod.VA)

## ZARA - ZARA LIGHT p.188-189

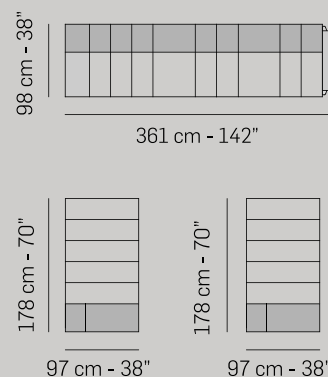

**Divano Zara e Zara Light (Cod.3002+L2201) (Cod.6033+6033)**  
**(Cod.3002)** Leather | Nevada 2415 Cat.2000 - Legs | Wooden legs in black gloss lacquered (Cod.27)  
**(Cod.L2201+6033)** Fabric | Amo Col.08 Cat.G - Atelier Collection -  
 Armrest: Nevada 2415 Cat.2000 - Legs | Wooden legs in black gloss lacquered (Cod.27)

**Pillows** CU51 n° 2 Fabric | Amo Col.08 Cat.G - Atelier Collection -  
 CU81 Fabric | Amo Col.08 Cat.G - Atelier Collection -  
 CU51 n° 2 Fabric | Dod Col.18 Cat.G - Tech Velvet Collection

**Monet coffee table (Cod.9511+9512)** Top | Verde Alpi marble (Cod.VA) -  
 Structure | Titanium metal (Cod.58)

**Mondrian coffee table (Cod.9511)** Top | Verde Alpi marble (Cod.VA) -  
 Structure | Verde Alpi marble (Cod.VA)



**Divano Zara e Zara Light (Cod.3002+6033+L2201)**  
**(Cod.3002)** Pelle | Nevada 2415 Cat.2000 - Piedini | Nero laccato lucido (Cod.27)  
**(Cod.L2201+6033)** Tessuto | Amo Col.08 Cat.G - Atelier Collection -  
 Bracciolo: Nevada 2415 Cat.2000 - Piedini | Nero laccato lucido (Cod.27)

**Cuscini** CU51 n° 2 Tessuto | Amo Col.08 Cat.G - Atelier Collection -  
 CU81 Tessuto | Amo Col.08 Cat.G - Atelier Collection -  
 CU51 Tessuto | Dod Col.18 Cat.G - Tech Velvet Collection

**Poltrona Ghirla (Cod.1000)** Tessuto | San Col.01 Cat.G - Atelier  
 Collection - Piede | Legno finitura Wengè (Cod.05)

**Tavolino Monet (Cod.9511+9512)** Ripiano | marmo Verde Alpi (Cod.VA) -  
 Struttura | metallo Titanio (Cod.58)

## ZARA - ZARA LIGHT p.190-191

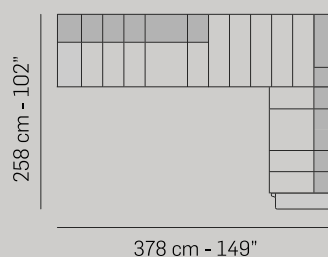

**Zara and Zara Light sofa (Cod.3002+6033+L2201)**  
**(Cod.3002)** Leather | Nevada 2415 Cat.2000 - Legs | Wooden legs in black gloss lacquered (Cod.27)  
**(Cod.L2201+6033)** Fabric | Amo Col.08 Cat.G - Atelier Collection -  
 Armrest: Nevada 2415 Cat.2000 - Legs | Wooden legs in black gloss lacquered (Cod.27)

**Pillows** CU51 n° 2 Fabric | Amo Col.08 Cat.G - Atelier Collection -  
 CU81 Fabric | Amo Col.08 Cat.G - Atelier Collection -  
 CU51 Fabric | Dod Col.18 Cat.G - Tech Velvet Collection

**Ghirla armchair (Cod.1000)** Fabric | San Col.01 Cat.G - Atelier Collection -  
 Legs | Wooden legs in Wengè (Cod.05)

**Monet coffee table (Cod.9511+9512)** Top | Verde Alpi marble (Cod.VA) -  
 Structure | Titanium metal (Cod.58)



# AMALFI

Design Application N° 40202200001046

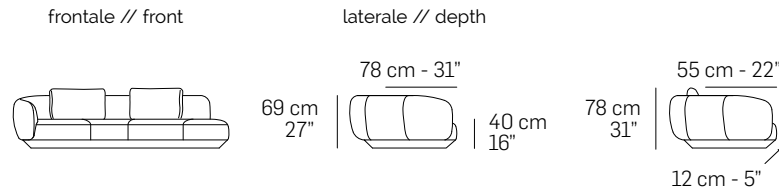

## Caratteristiche standard

- Struttura in multistrato, massello di abete e molleggio seduta con cinghie elastiche.
- Imbottiture in poliuretano espanso ecologico a cellula aperta con densità differenziate.
- Cuscini di schienale in fibra "Extra soft".
- Rivestimento in pelle o tessuto. Tutti i rivestimenti sono fissi, con cuscini di spalliera sfoderabili.
- Piedi in materiale termoplastico nero.
- Cucitura Cod.01 + Cod.03 per rivestimento in pelle.
- Cucitura Cod.03 per rivestimento in tessuto.
- Inserimento letto non possibile.
- Lato componibile rifinito.

## Caratteristiche optional su richiesta senza maggiorazione

- Nessuna maggiorazione in caso di scelta dei soli cuscini schienale con rivestimento differente da quello principale.
- Disponibile con cucitura a contrasto, per la scelta del colore fare riferimento ai codici del campionario pelli.

## Caratteristiche optional su richiesta con maggiorazione

- Per il multi rivestimento il prezzo va incrementato del 7%, ad eccezione di quanto riportato nel paragrafo "senza maggiorazione". Per maggiori dettagli fare riferimento al paragrafo "NOTE" posto nelle prime pagine del listino.
- Ogni versione comprende un numero di cuscini di schienale pari a quanto riportato nello stesso schema (disegno versione). Eventuali cuscini supplementari potranno essere ordinati singolarmente. Vedi Cod. 9050.

## Note

- Non è possibile applicare altre cuciture.
- Per alcuni tessuti e velluti l'azienda si riserva di applicare la cucitura Cod.00 / Cod.03 (vedi immagine).

## Standard features

- Frame: wooden structure, solid fir wood and seat suspensions in reinforced elastic webbing.
- Paddings in eco-friendly open cell polyurethane foam, with different densities.
- Back cushions in "Extra soft" fiber.
- Covering in leather or fabric. Back cushions coverings removable.
- Legs in black thermoplastic material.
- Stitching type Cod.01 + Cod.03 for leather covering.
- Stitching type Cod.03 for fabric covering.
- No bed version available.
- Finished sectional sides.

## Optional features available upon request without any upcharge

- No upcharge in case of back cushions only with different covering from the primary one.
- Stitching, unless differently requested, will be matching the leather or fabric colour. Contrast stitching colour can be ordered at no extra charge. You might use as reference any Nicoline leather.

## Optional features available upon request with an upcharge

- 7% upcharge for combined coverings, except as indicated in the paragraph "without any upcharge". Please refer to the notes at the beginning of pricelist.
- Each version includes as many back cushions as shown in the same diagram (version drawing). Any additional cushions can be ordered individually. Please refer to Code 9050

## Notes

- Different stitchings not available.
- For some fabrics and velvets production dept. must apply the stitching Cod.00 / Cod.03 (as per picture below).

Cuciture //  
Stitching

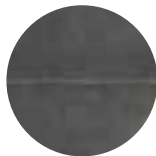

Cod.00

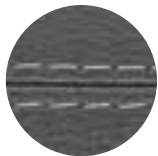

Cod.01

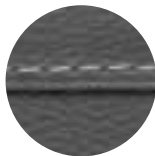

Cod.03

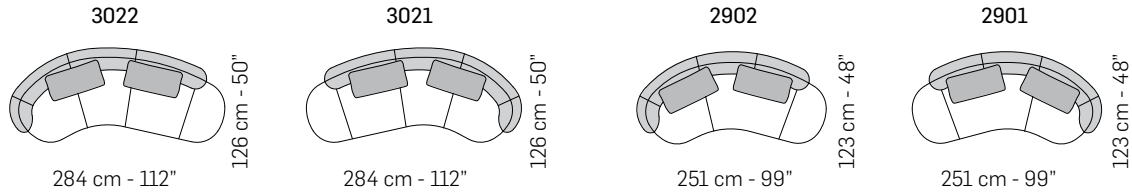

A

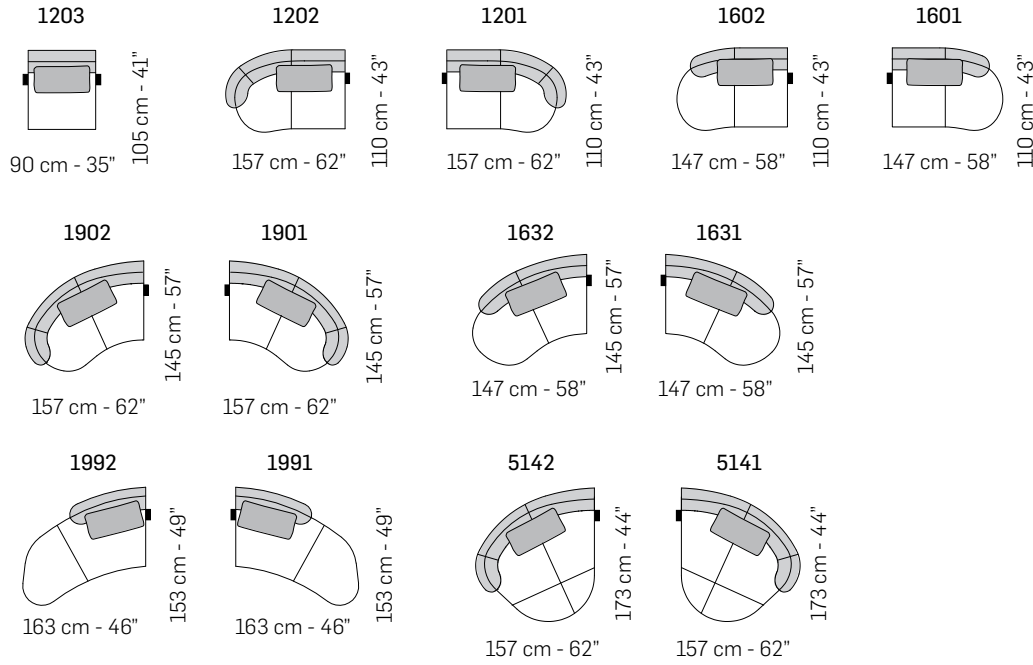

tutti gli elementi del gruppo A hanno lo stesso modulo di seduta - all items in group A have the same seat width

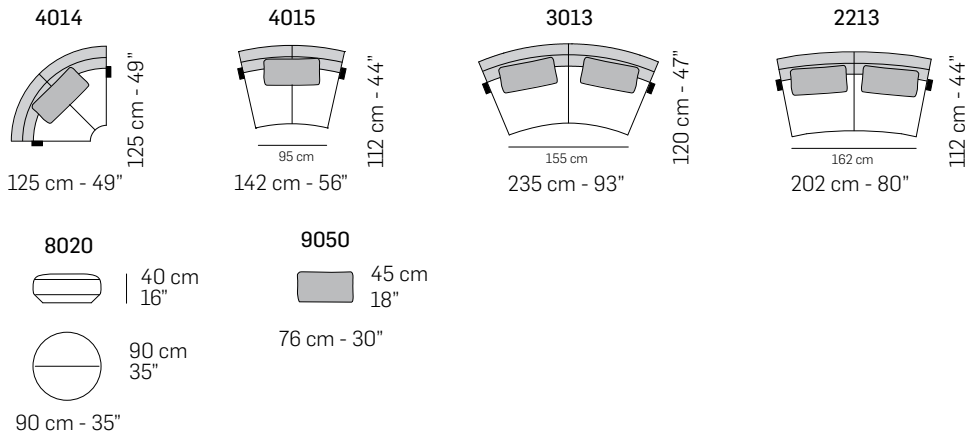

COMPOSIZIONI CONSIGLIATE / SUGGESTED COMPOSITIONS

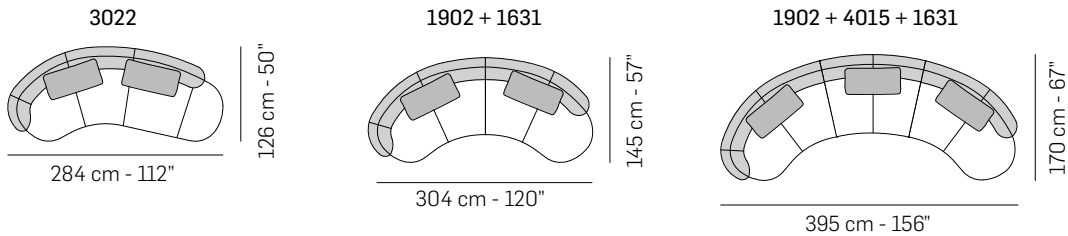

Scala 1:100  
Ratio 1 to 100

Legenda / Legend

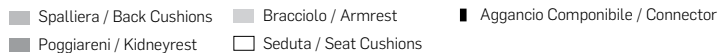

Note / Notes

Nicoline si riserva il diritto di apportare in ogni momento modifiche tecniche ed estetiche / Nicoline reserves the right to change, at any time and without prior warning, technical and aesthetic specifications of the articles.

# ASTEDIO

Design Application N° 40202200001046



frontale // front

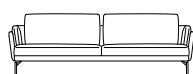

laterale // depth

51 cm - 20"



94 cm - 37"

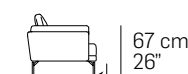

18 cm - 7"

## Caratteristiche standard

- Struttura in multistrato, massello di abete e molleggio seduta con cinghie elastiche.
- Imbottiture in poliuretano espanso ecologico a cellula aperta con densità differenziate.
- Cuscini di schienale in fibra "Extra soft".
- Rivestimento in pelle o tessuto con cuscini di seduta, spalliera e braccioli sfoderabili.
- Solo per il mercato ITALIA il rivestimento in tessuto è completamente sfoderabile.
- Elementi Cod.1421 - 1422 - 1671 - 1672 - 2341 - 2342 - 3031 - 3032 - 3451 - 3452 - 9507 con ripiano in marmo Bianco Carrara (Cod.CA).
- Piede (PM001) in metallo Canna di fucile (Cod.50), Bronzo anticato (Cod.52).
- Cucitura Cod.01 + Cod.03 per rivestimento in pelle.
- Cucitura Cod.03 per rivestimento in tessuto.
- Inserimento letto non possibile.
- Lato componibile rifinito

## Caratteristiche optional su richiesta senza maggiorazione

- Piede (PM002) in metallo Canna di fucile (Cod.50), Bronzo anticato (Cod.52).
- Disponibile con cucitura a contrasto, per la scelta del colore fare riferimento ai codici del campionario pelli.

## Caratteristiche optional su richiesta con maggiorazione

- Per il multi rivestimento il prezzo va incrementato del 7%. Per maggiori dettagli fare riferimento al paragrafo "NOTE" posto nelle prime pagine del listino.
- Elementi Cod.1421 - 1422 - 1671 - 1672 - 2341 - 2342 - 3031 - 3032 - 3451 - 3452 - 9507 con ripiano in marmo Emperador (Cod.EM), Nero Marquinia (Cod.NM).

## Note

- I disegni grafici che riportano l'asterisco (\*) sono sempre con lato rifinito e anche agganciabili agli elementi componibili
- Non è possibile applicare altre cuciture.
- Per alcuni tessuti e velluti l'azienda si riserverà di applicare la cucitura Cod.00 / Cod.03 (vedi immagine).

## Standard features

- Frame: wooden structure, solid fir wood and seat suspensions in reinforced elastic webbing.
- Paddings in eco-friendly open cell polyurethane foam, with different densities.
- Back cushions in "Extra soft" fiber.
- Covering in leather or fabric. Armrest, seat and back cushions coverings removable.
- Versions Cod.1421 - 1422 - 1671 - 1672 - 2341 - 2342 - 3031 - 3032 - 3451 - 3452 - 9507 with top in White Carrara marble (Cod.CA).
- Legs (PM001) in Gunmetal (Cod.50), Antique bronze (Cod.52).
- Stitching type Cod.01 + Cod.03 for leather covering.
- Stitching type Cod.03 for fabric covering.
- No bed version available.
- Sectional sides finished.

## Optional features available upon request without any upcharge

- Legs (PM002) in Gunmetal (Cod.50), Antique bronze (Cod.52).
- Stitching, unless differently requested, will be matching the leather or fabric colour. Contrast stitching colour can be ordered at no extra charge. You might use as reference any Nicoline leather.

## Optional features available upon request with an upcharge

- 7% upcharge for combined coverings. Please refer to the notes at the beginning of pricelist.
- Versions Cod.1421 - 1422 - 1671 - 1672 - 2341 - 2342 - 3031 - 3032 - 3451 - 3452 - 9507 with top in Emperador marble (Cod.EM), Black Marquinia marble (Cod.NM).

## Notes

- Versions with asterisk (\*) have always the terminal side finished with the possibility to be connected to modular elements.
- Different stitchings not available.
- For some fabrics and velvets production dept. must apply the stitching Cod.00 / Cod.03 (as per picture below).



Piede in metallo standard // Metal leg standard (PM001)



Piede in metallo opzionale // Metal leg optional (PM002)



Canna di Fucile (Cod.50) // Gunmetal (Cod.50)



Bronzo Anticato (Cod.52) // Antique Bronze (Cod.52)

Cuciture // Stitching



Cod.00

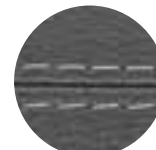

Cod.01

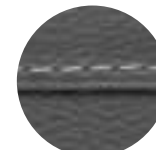

Cod.03

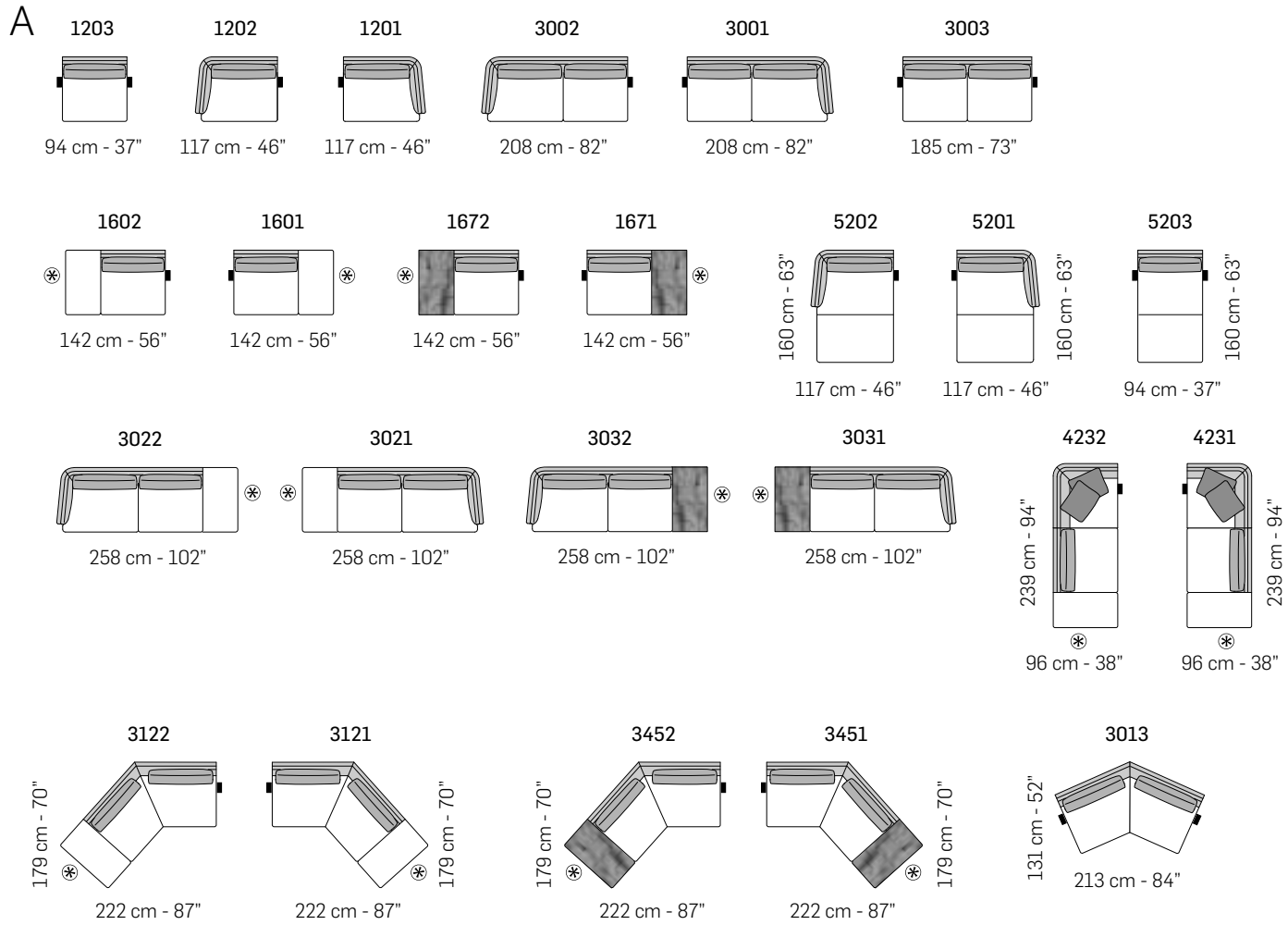
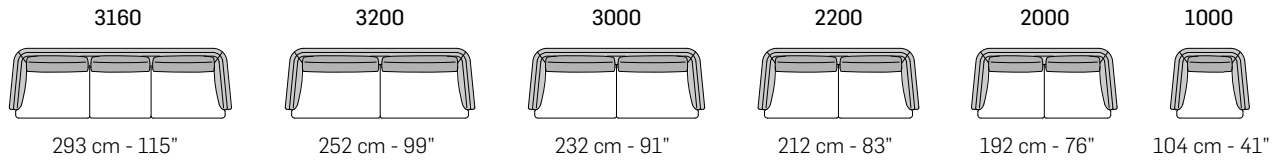

tutti gli elementi del gruppo A hanno lo stesso modulo di seduta - all items in group A have the same seat width

B

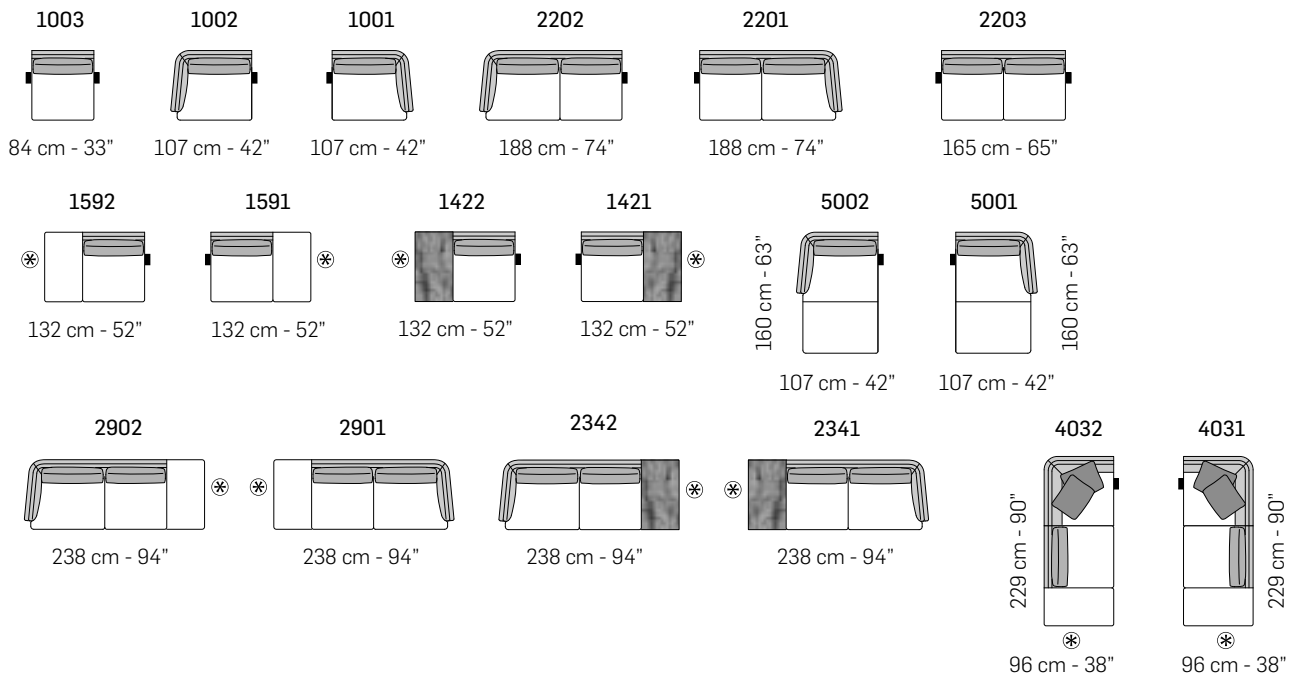

tutti gli elementi del gruppo B hanno lo stesso modulo di seduta - all items in group B have the same seat width

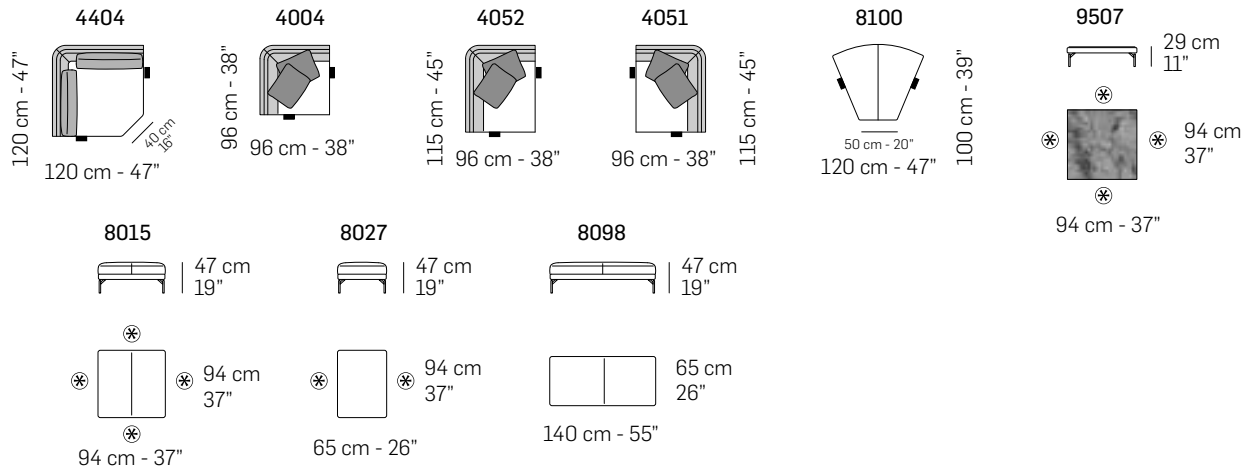

CUSCINETTI CONSIGLIATI / SUGGESTED PILLOWS

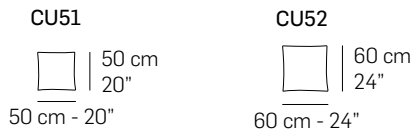

COMPOSIZIONI CONSIGLIATE / SUGGESTED COMPOSITIONS

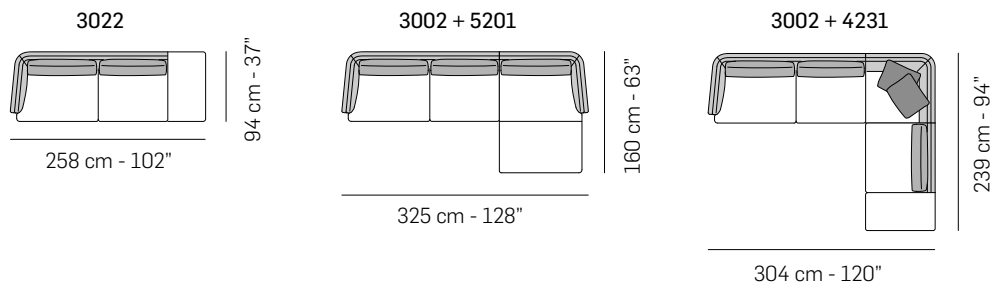

Scala 1:100  
Ratio 1 to 100

Legenda / Legend

- Spalliera / Back Cushions
- Bracciolo / Armrest
- Marmo / Marble
- Poggiareni / Kidneyrest
- Seduta / Seat Cushions
- ⊗ Lato terminale sempre rifinito e agganciabile agli elementi componibili / Terminal side is always finished and it can also be connected to modular elements
- Aggancio Componibile / Connector

Note / Notes

Nicoline si riserva il diritto di apportare in ogni momento modifiche tecniche ed estetiche / Nicoline reserves the right to change, at any time and without prior warning, technical and aesthetic specifications of the articles.





# AURA

Design Application N° 008643290-0001

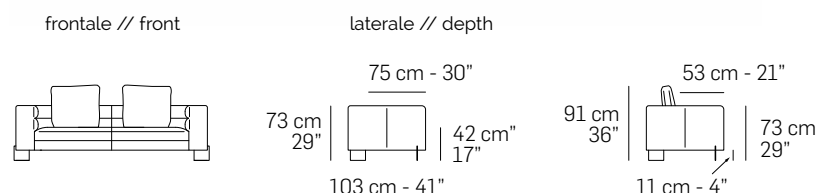

## Caratteristiche standard

- Struttura in multistrato, massello di abete e molleggio seduta con cinghie elastiche.
- Imbottiture in poliuretano espanso ecologico a cellula aperta con densità differenziate.
- Cuscini di schienale in fibra "Extra soft".
- Rivestimento in pelle o tessuto con cuscini di seduta e spalliera sfoderabili.
- Elementi Cod.1421 - 1422 - 1671 - 1672 - 3031 - 3032 - 3051 - 3052 - 3221 - 3222 - S3031 - S3032 - 9507 con ripiano in marmo Bianco Carrara (Cod.CA).
- Piede in metallo Canna di fucile (Cod.50), Ottone satinato (Cod.51), Bronzo anticato (Cod.52).
- Cucitura Cod.01 + Cod.03 per rivestimento in pelle.
- Cucitura Cod.03 per rivestimento in tessuto.
- Inserimento letto non possibile.
- Lato componibile rifinito.

## Caratteristiche optional su richiesta senza maggiorazione

- Nessuna maggiorazione in caso di scelta dei soli cuscini schienale con rivestimento differente da quello principale.
- Disponibile con cucitura a contrasto, per la scelta del colore fare riferimento ai codici del campionario pelli.

## Caratteristiche optional su richiesta con maggiorazione

- Per il multi rivestimento il prezzo va incrementato del 7%, ad eccezione di quanto riportato nel paragrafo "senza maggiorazione". Per maggiori dettagli fare riferimento al paragrafo "NOTE" posto nelle prime pagine del listino.
- Elementi Cod.1421 - 1422 - 1671 - 1672 - 3031 - 3032 - 3051 - 3052 - 3221 - 3222 - S3031 - S3032 - 9507 con ripiano in marmo Emperador (Cod.EM), Nero Marquinia (Cod.NM).
- Cuscino Cod.9010 realizzato con imbottitura in fibra di poliestere siliconata.
- Ogni versione comprende un numero di cuscini di schienale pari a quanto riportato nello stesso schema (disegno versione). Eventuali cuscini supplementari potranno essere ordinati singolarmente. Vedi Cod.9050 e Cod.9010.

## Note

- I disegni grafici che riportano l'asterisco (\*) sono sempre con lato rifinito e anche agganciabili agli elementi componibili.
- Non è possibile applicare altre cuciture.
- Per alcuni tessuti e velluti l'azienda si riserva di applicare la cucitura Cod.00 / Cod.03 (vedi immagine).

## Standard features

- Frame: wooden structure, solid fir wood and seat suspensions in reinforced elastic webbing.
- Paddings in eco-friendly open cell polyurethane foam, with different densities.
- Back cushions in "Extra soft" fiber.
- Covering in leather or fabric. Seat and back cushions coverings removable.
- Versions Cod.1421 - 1422 - 1671 - 1672 - 3031 - 3032 - 3051 - 3052 - 3221 - 3222 - S3031 - S3032 - 9507 with top in White Carrara marble (Cod.CA).
- Legs in Gunmetal (Cod.50), Satin brass (Cod.51), Antique bronze (Cod.52).
- Stitching type Cod.01 + Cod.03 for leather covering.
- Stitching type Cod.03 for fabric covering.
- No bed version available.
- Sectional sides finished.

## Optional features available upon request without any upcharge

- No upcharge for combined coverings in case you choose only back cushions in a different covering in leather or fabric.
- Stitching, unless differently requested, will be matching the leather or fabric colour. Contrast stitching colour can be ordered at no extra charge. You might use as reference any Nicoline leather.

## Optional features available upon request with an upcharge

- 7% upcharge for combined coverings, except as indicated in the paragraph "without any upcharge". Please refer to the notes at the beginning of pricelist.
- Versions Cod.1421 - 1422 - 1671 - 1672 - 3031 - 3032 - 3051 - 3052 - 3221 - 3222 - S3031 - S3032 - 9507 with top in Emperador marble (Cod.EM), Black Marquinia marble (Cod.NM).
- Cushion Cod. 9010 made with silicone polyester fiber padding.
- Each version includes a certain number of back cushions as shown in the version drawing. Any additional cushions can be ordered individually. Please consider cushions cod.9050 and Cod.9010.

## Notes

- Versions with asterisk (\*) have always the terminal side finished with the possibility to be connected to modular elements.
- Different stitchings not available.
- For some fabrics and velvets production dept. must apply the stitching Cod.00 / Cod.03 (as per picture below).



Piede in metallo // Metal legs

 Canna di Fucile (Cod.50) // Gunmetal (Cod.50)

 Ottone Satinato (Cod.51) // Satin Brass (Cod.51)

 Bronzo Anticato (Cod.52) // Antique Bronze (Cod.52)

Cuciture // Stitching



Cod.00

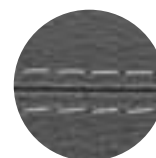

Cod.01

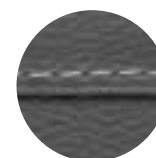

Cod.03

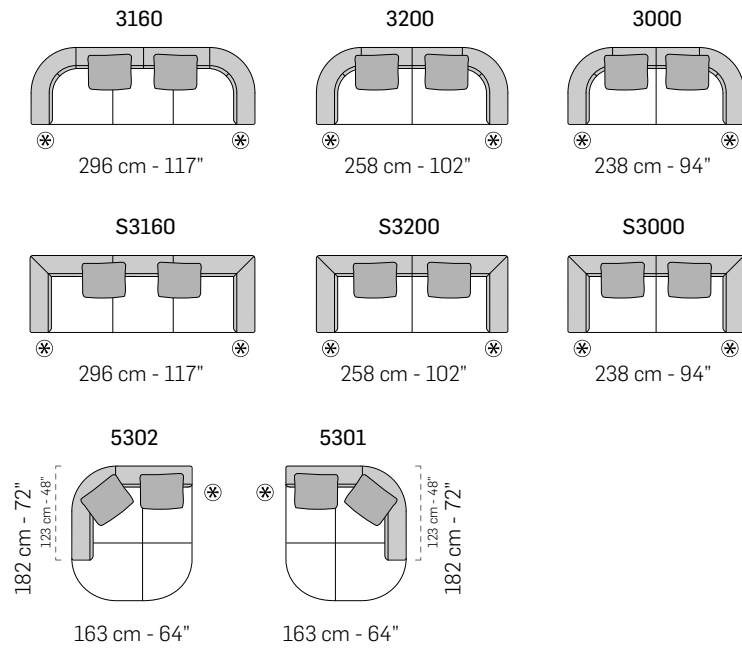

A

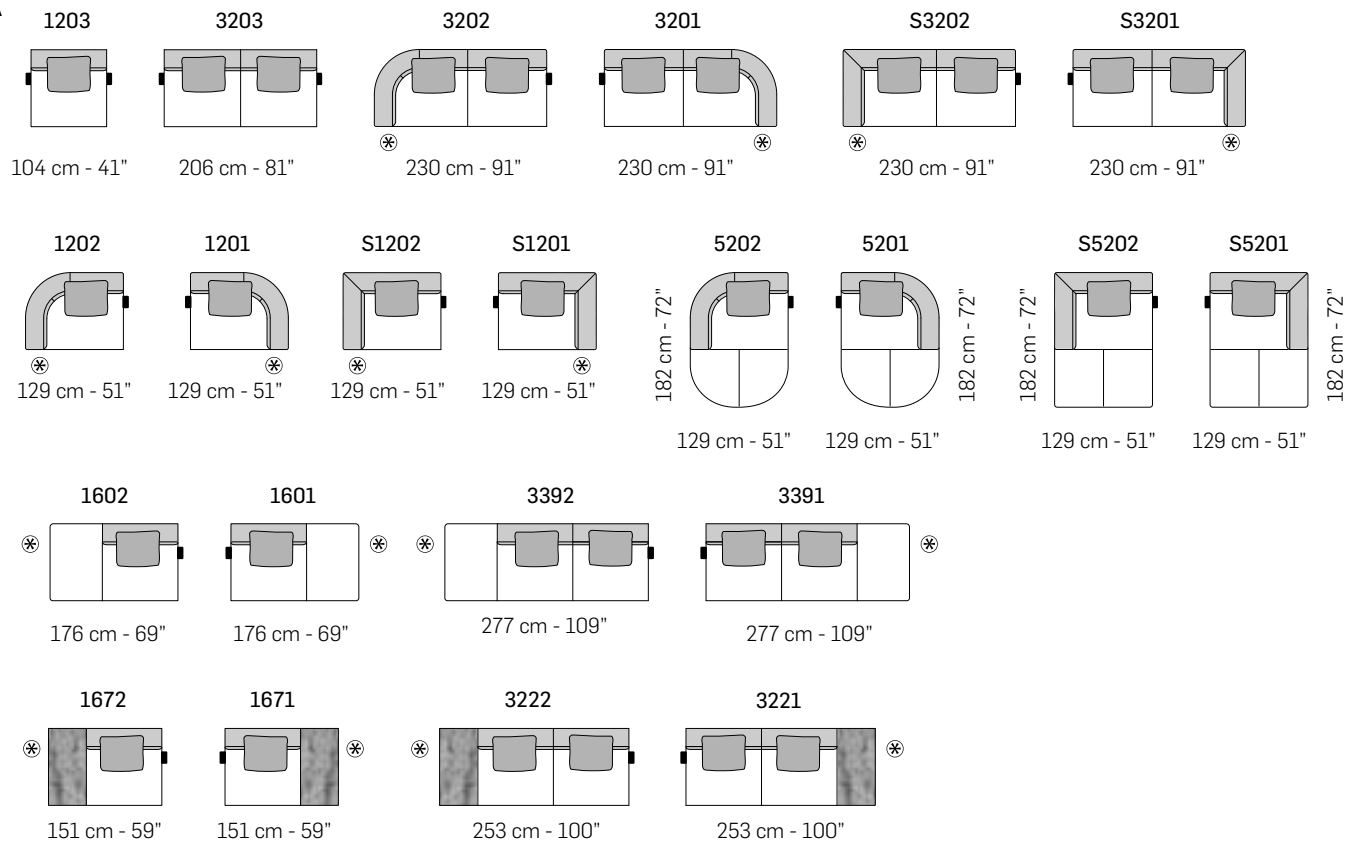

tutti gli elementi del gruppo A hanno lo stesso modulo di seduta - all items in group A have the same seat width

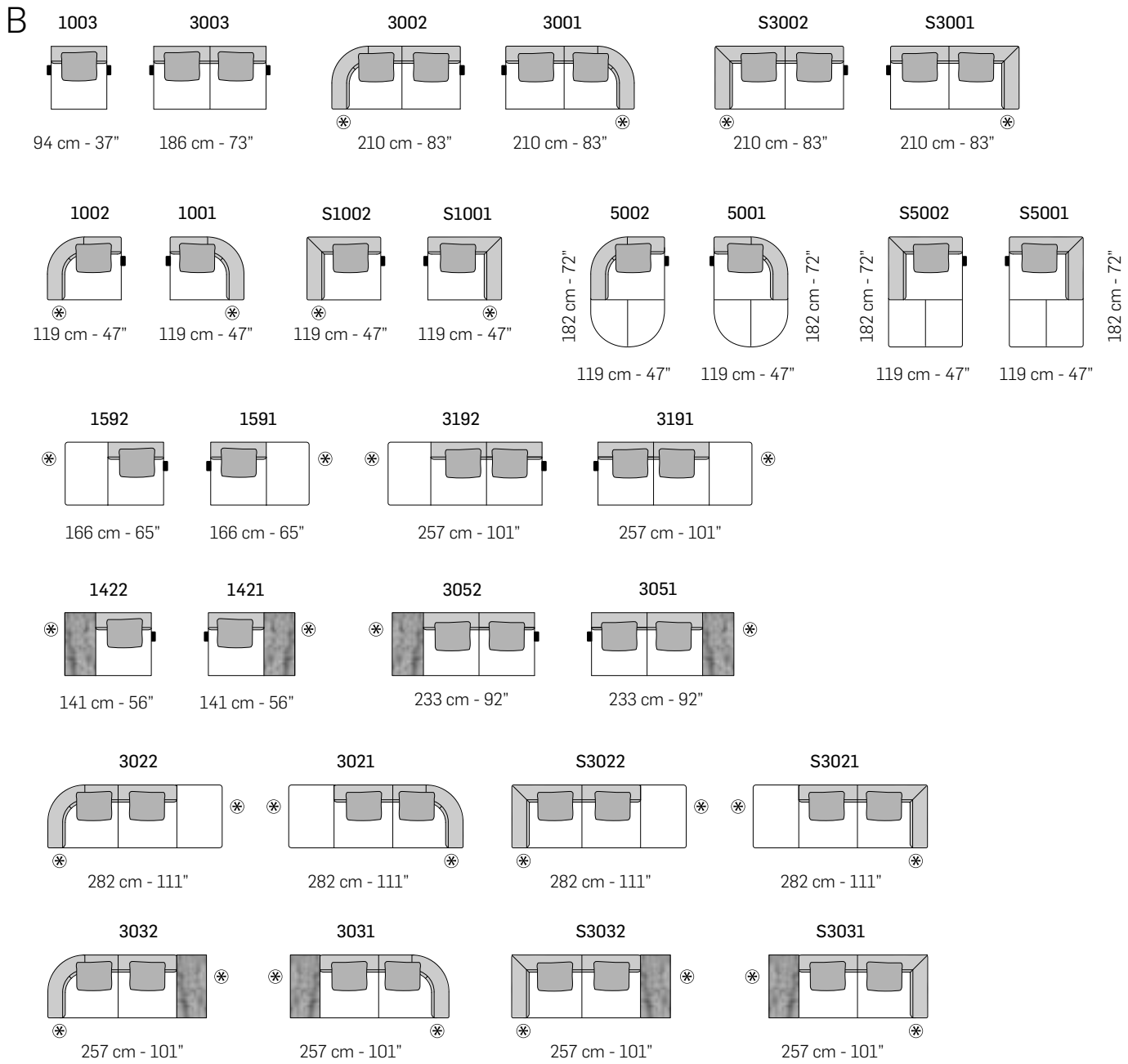

tutti gli elementi del gruppo B hanno lo stesso modulo di seduta - all items in group B have the same seat width

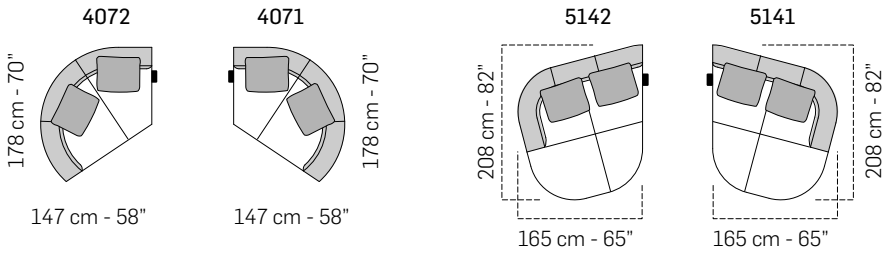
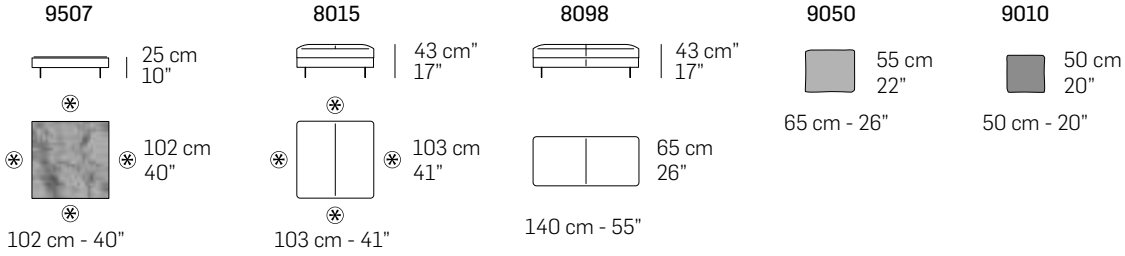
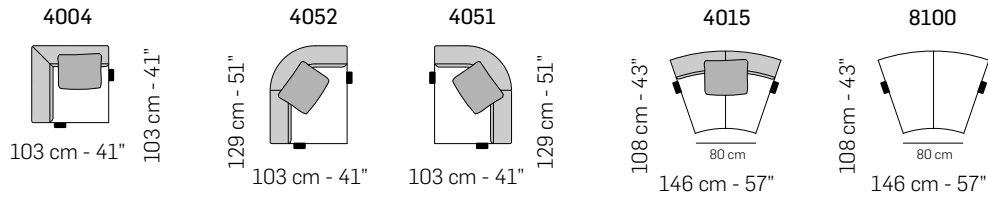

COMPOSIZIONI CONSIGLIATE / SUGGESTED COMPOSITIONS

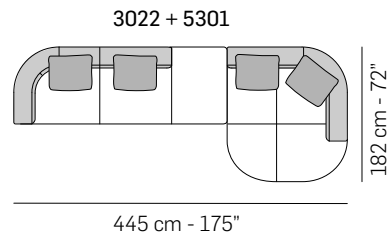
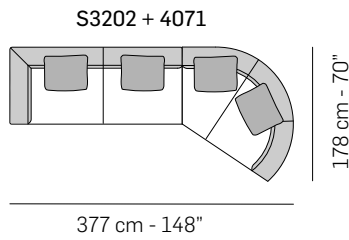
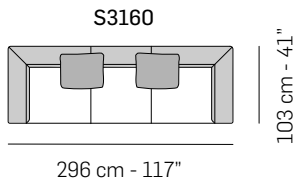

Scala 1:100  
Ratio 1 to 100

Legenda / Legend

- Spalliera / Back Cushions
- Bracciolo / Armrest
- Marmo / Marble
- Poggiareni / Kidneyrest
- Seduta / Seat Cushions
- ⊗ Lato terminale sempre rifinito e agganciabile agli elementi componibili / Terminal side is always finished and it can also be connected to modular elements
- Aggancio Componibile / Connector

Note / Notes

Nicoline si riserva il diritto di apportare in ogni momento modifiche tecniche ed estetiche / Nicoline reserves the right to change, at any time and without prior warning, technical and aesthetic specifications of the articles.

# BORA

Design Application N° 402017000039849



frontale // front



laterale // depth

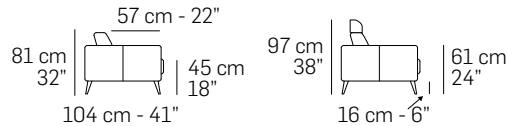

### Caratteristiche standard

- Struttura in legno e multistrato, molleggio seduta con cinghie elastiche.
- Imbottitura in poliuretano espanso ecologico a cellula aperta con densità differenziate.
- Rivestimento in pelle o tessuto con cuscini di seduta e spalliera sfoderabili.
- Solo per il mercato ITALIA il rivestimento in tessuto è completamente sfoderabile.
- Piede in metallo Lucido (Cod.30), Satinato (Cod.31), Canna di fucile (Cod.50), Bronzo anticato (Cod.52).
- Elementi Cod.1501 - 1502 - 1671 - 1672 - 2341 - 2342 - 3031 - 3032 - 8091 con ripiano in marmo Emperador (Cod.EM) oppure con marmo Bianco Carrara (Cod.CA).
- Cucitura Cod.06 per rivestimento in pelle.
- Inserimento letto non possibile.
- Lato componibile rifinito.

### Caratteristiche optional su richiesta senza maggiorazione

- Disponibile con cucitura a contrasto, per la scelta del colore fare riferimento ai codici del campionario pelli.

### Caratteristiche optional su richiesta con maggiorazione

- Poggiatesta (Cod.9900) con imbottitura in poliuretano espanso ecologico a cellula aperta e rivestimento sfoderabile.
- Per il multi rivestimento il prezzo va incrementato del 3%. Per maggiori dettagli fare riferimento al paragrafo "NOTE" posto nelle prime pagine del listino.

### Note

- I disegni grafici che riportano l'asterisco (\*) sono sempre con lato rifinito e anche agganciabili agli elementi componibili.
- Non è possibile applicare altre cuciture.

### Standard features

- Frame: wooden structure, seat suspensions in reinforced elastic webbing.
- Padding in eco-friendly open cell polyurethane foam, with different densities.
- Covering in leather or fabric. Seat and back cushions coverings removable.
- Legs in Shiny metal (Cod.30), Satin (Cod.31), Gunmetal (Cod.50), Antique bronze (Cod.52).
- Versions Cod.1501- 1502 - 1671- 1672- 2341- 2342 - 3031- 3032- 8091 with top in marble Emperador (Cod.EM) or White Carrara marble (Cod.CA).
- Stitching type Cod.06 for leather covering.
- No bed version available.
- Finished sectional sides.

### Optional features without any upcharge

- Contrast stitching available. Please refer to our leather collection for a thread color indication.

### Optional features with upcharge

- Headrest (Cod.9900) with padding in eco-friendly open cell polyurethane foam. Removable covering.
- 3% upcharge for combined coverings. Please refer to the notes at the beginning of pricelist.

### Notes

- Versions with asterisk (\*) have always the finished terminal side with the possibility to be connected to modular elements.
- Different stitchings not available.



Metallo Lucido  
(Cod.30) //  
Shiny Metal  
(Cod.30)



Metallo Satinato  
(Cod.31) //  
Satin Metal  
(Cod.31)



Canna di Fucile  
(Cod.50) //  
Gunmetal  
(Cod.50)



Bronzo Anticato  
(Cod.52) //  
Antique Bronze  
(Cod.52)

Cuciture //  
Stitching

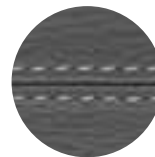

Cod.06

Piede in metallo //  
Metal legs

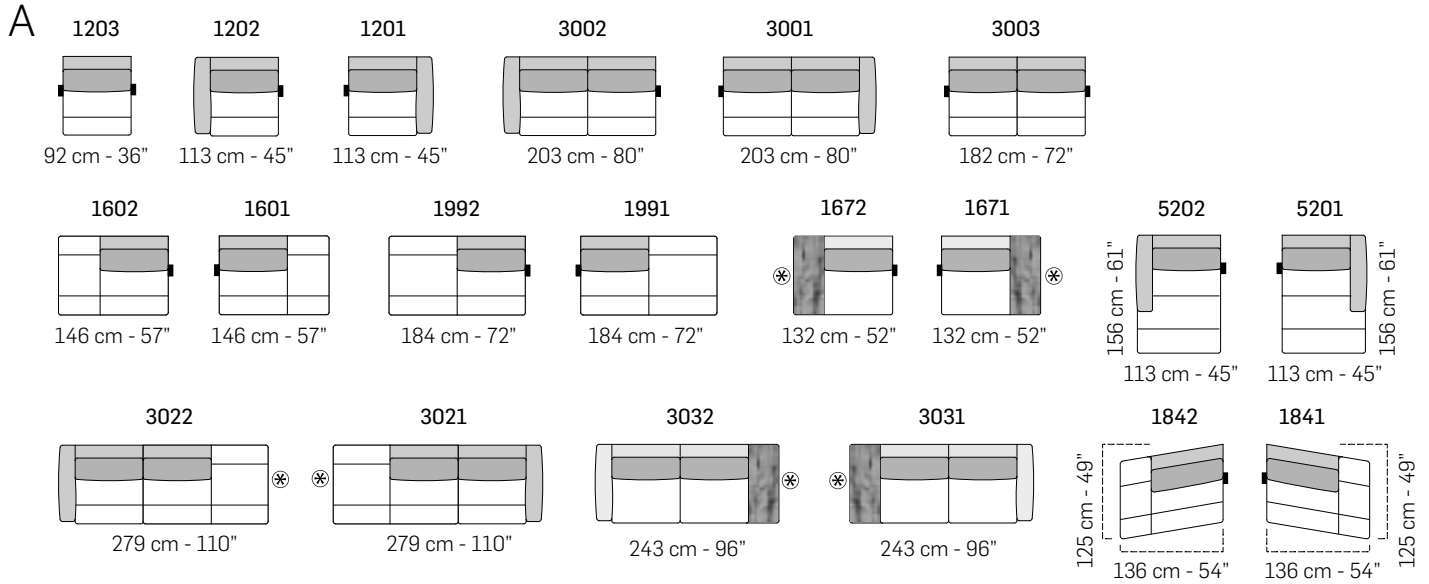
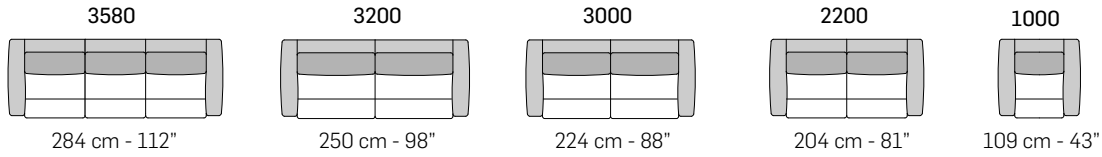

tutti gli elementi del gruppo A hanno lo stesso modulo di seduta - all items in group A have the same seat width

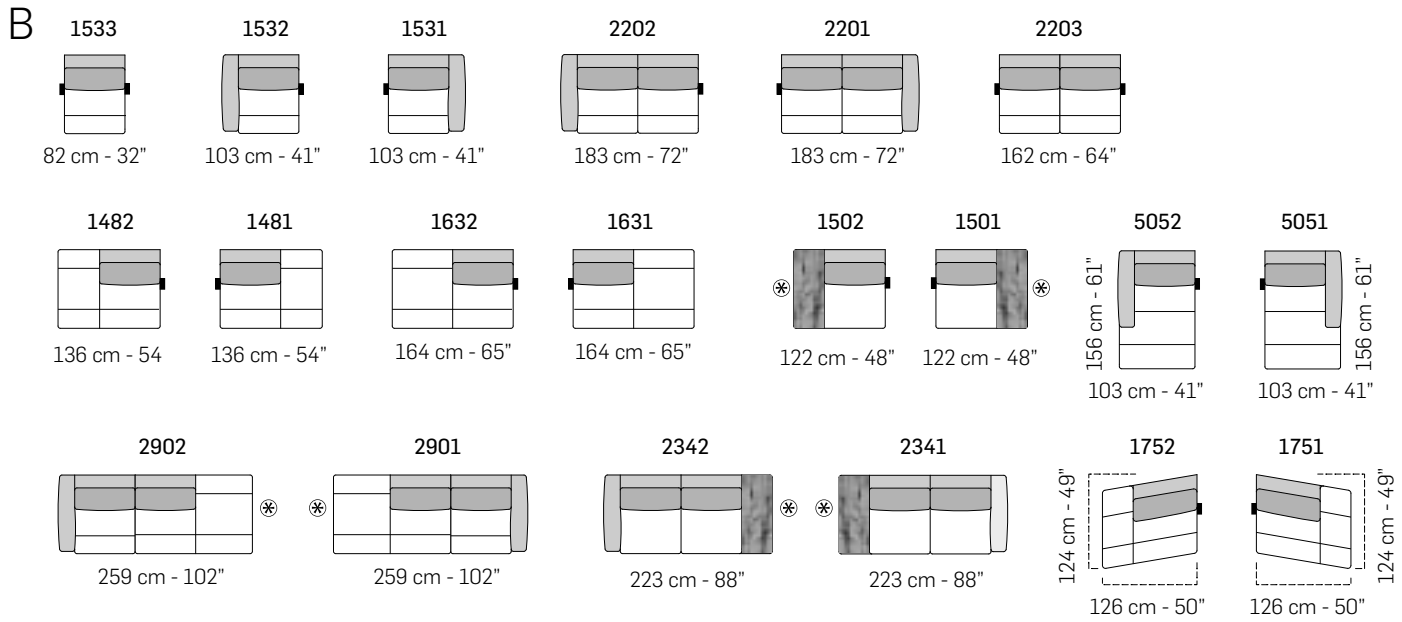

tutti gli elementi del gruppo B hanno lo stesso modulo di seduta - all items in group B have the same seat width

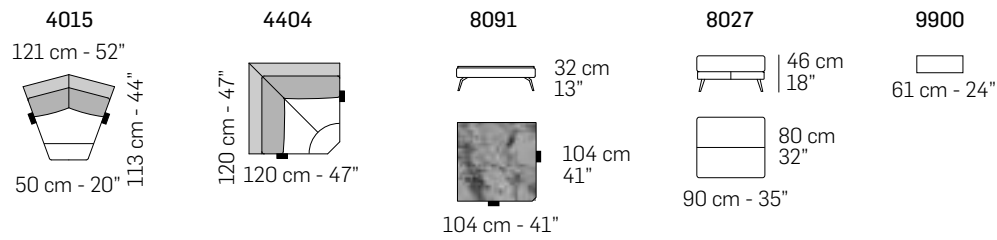

COMPOSIZIONI CONSIGLIATE / SUGGESTED COMPOSITIONS

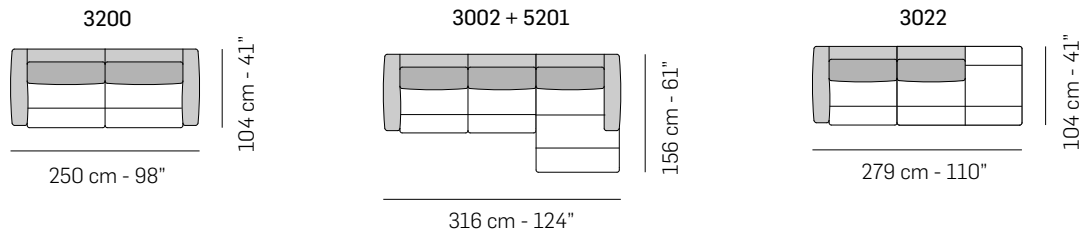

Scala 1:100  
Ratio 1 to 100

Legenda / Legend

- Spalliera / Back Cushions
- Bracciolo / Armrest
- Marmo / Marble
- Poggiareni / Kidneyrest
- Seduta / Seat Cushions

⊗ Lato terminale sempre rifinito e agganciabile agli elementi componibili / Terminal side is always finished and it can also be connected to modular elements

■ Aggancio Componibile / Connector

Note / Notes

Nicoline si riserva il diritto di apportare in ogni momento modifiche tecniche ed estetiche / Nicoline reserves the right to change, at any time and without prior warning, technical and aesthetic specifications of the articles.





# BOVISA

Design Application N° 402017000039849



frontale // front

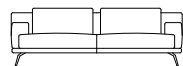

laterale // depth

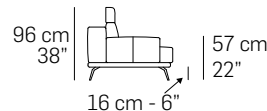
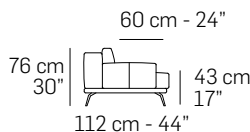

## Caratteristiche standard

- Struttura in legno e multistrato con supporto in metallo, molleggio seduta con cinghie elastiche.
- Cuscini di seduta in poliuretano espanso ecologico a cellula aperta con densità differenziate.
- Cuscini di spalliera in piuma.
- Rivestimento in pelle o tessuto con cuscini di seduta e spalliera sfoderabili.
- Solo per il mercato ITALIA il rivestimento in tessuto è completamente sfoderabile.
- Piedi in metallo Lucido (Cod.30), Satinato (Cod.31), Canna di fucile (Cod.50), Bronzo anticato (Cod.52).
- Elementi Cod.1421- 1422- 1671- 1672- 1801- 1802- 2341- 2342- 2371- 2372 - 3031- 3032- 3051- 3052- 3221- 3222- 3451- 3452- 8091 con ripiano in marmo Emperador (Cod.EM) oppure marmo Bianco Carrara (Cod.CA).
- Cucitura Cod.03 per rivestimento in pelle e tessuto.
- Inserimento letto non possibile.
- Lato componibile rifinito.

## Caratteristiche optional su richiesta senza maggiorazione

- Disponibile con cucitura a contrasto, per la scelta del colore fare riferimento ai codici del campionario pelli.

## Caratteristiche optional su richiesta con maggiorazione

- Poggiatesta (Cod.9900) con imbottitura in piuma e supporto in metallo rivestito.
- Per il multi rivestimento il prezzo va incrementato del 7%. Per maggiori dettagli fare riferimento al paragrafo "NOTE" posto nelle prime pagine del listino.

## Note

- I disegni grafici che riportano l'asterisco (\*) sono sempre con lato rifinito e anche agganciabili agli elementi componibili
- Non è possibile applicare altre cuciture.
- Per alcuni tessuti e velluti l'azienda si riserverà di applicare la cucitura Cod.00/ Cod.03 (vedi immagine).

## Standard features

- Frame: wooden structure with metal support, seat suspensions in reinforced elastic webbing.
- Seat cushions in eco-friendly open cell polyurethane foam, with different densities.
- Back cushions in feather.
- Covering in leather or fabric. Seat and back cushions coverings removable.
- Legs in Shiny metal (Cod.30), Satin (Cod.31), Gunmetal (Cod.50), Antique bronze (Cod.52).
- Versions Cod.1421- 1422- 1671- 1672- 1801- 1802- 2341- 2342- 2371- 2372 - 3031- 3032- 3051- 3052- 3221- 3222- 3451- 3452- 8091 with top in marble Emperador (Cod.EM) or White Carrara marble (Cod.CA).
- Stitching type Cod.03 for leather and fabric coverings.
- No bed version available.
- Finished sectional sides.

## Optional features without any upcharge

- Contrast stitching available. Please refer to our leather collection for a thread color indication.

## Optional features with upcharge

- Headrest (Cod.9900) with feather padding and covered metal structure.
- 7% upcharge for combined coverings. Please refer to the notes at the beginning of pricelist.

## Notes

- Versions with asterisk (\*) have always the finished terminal side with the possibility to be connected to modular elements.
- Different stitchings not available.
- For some fabrics and velvets production dept. must apply the stitching Cod.00/ Cod.03 (as per picture below).



Piede in metallo // Metal legs

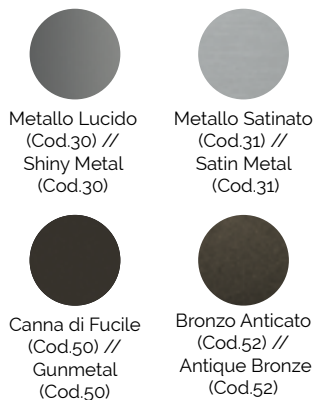

Elementi // Versions



Cuciture // Stitching

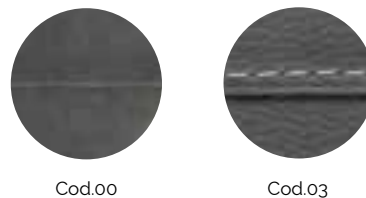

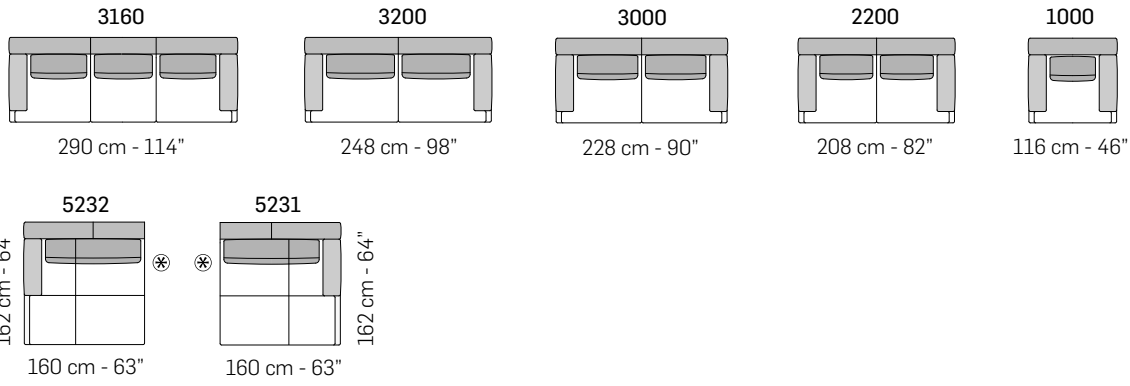

A

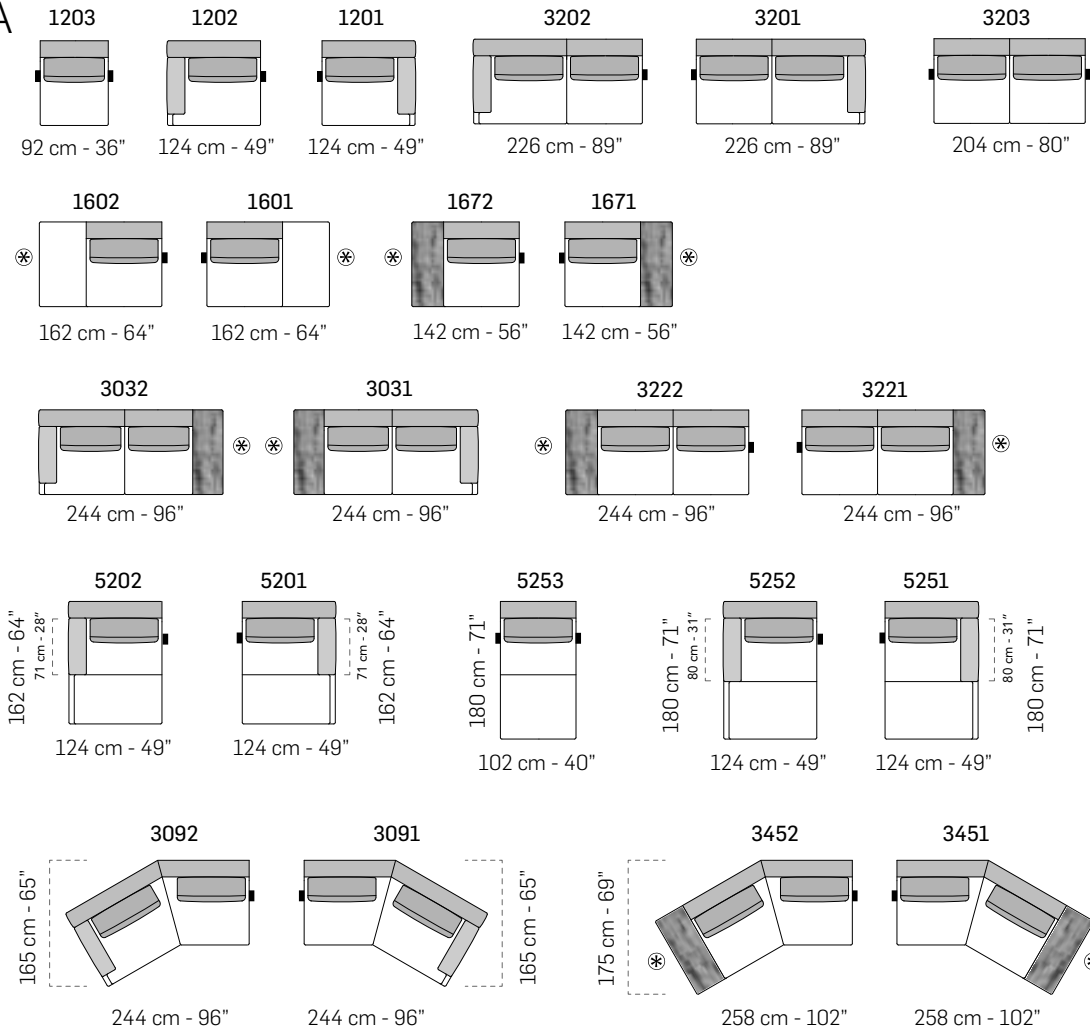

tutti gli elementi del gruppo C hanno lo stesso modulo di seduta - all items in group C have the same seat width

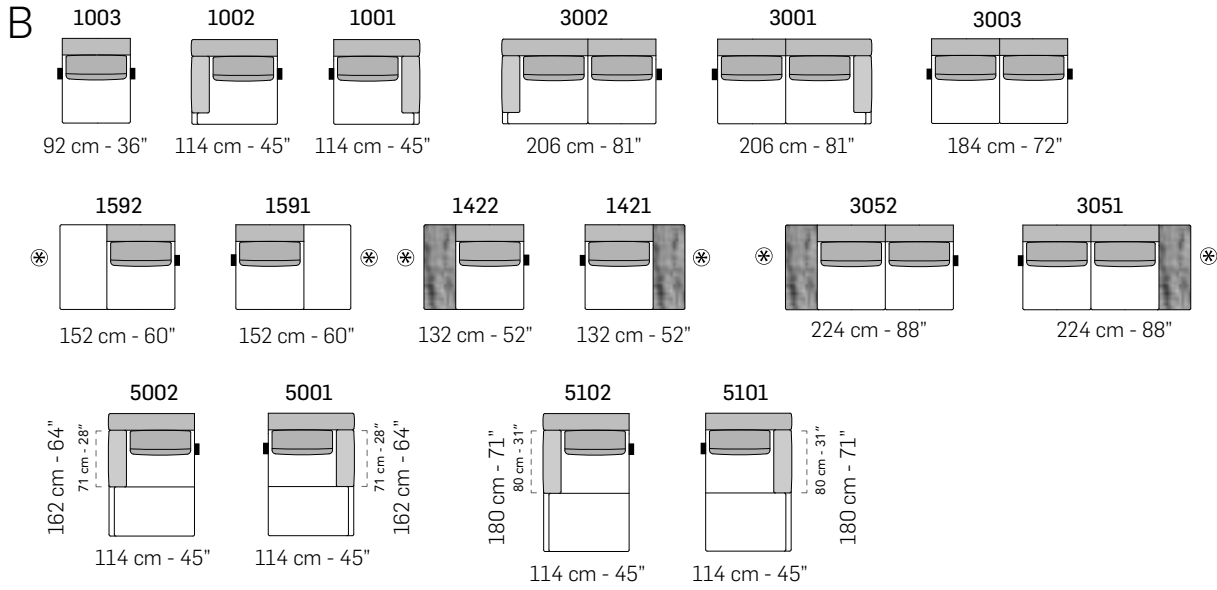

tutti gli elementi del gruppo B hanno lo stesso modulo di seduta - all items in group B have the same seat width

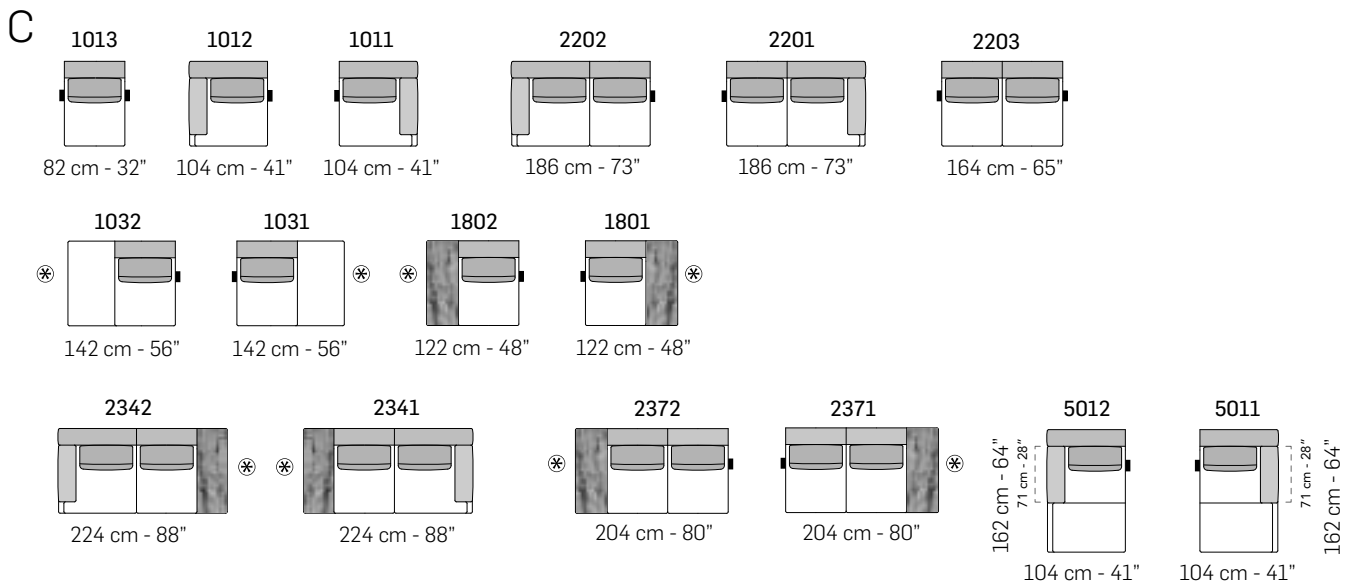

tutti gli elementi del gruppo C hanno lo stesso modulo di seduta - all items in group C have the same seat width

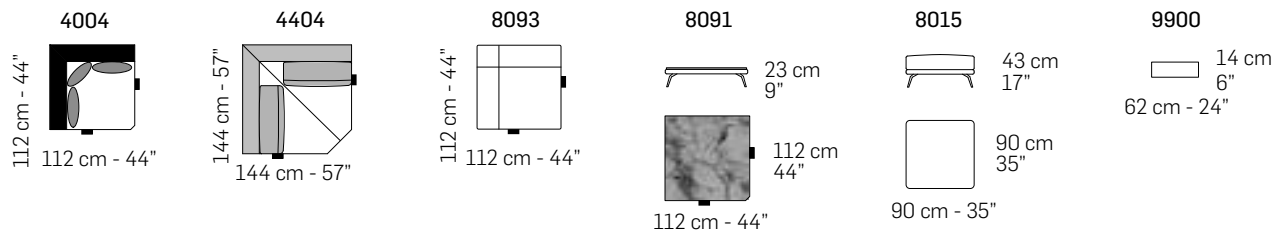

COMPOSIZIONI CONSIGLIATE / SUGGESTED COMPOSITIONS

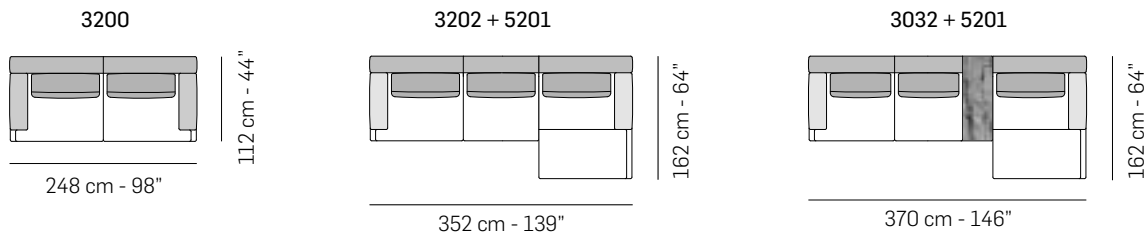

Scala 1:100  
Ratio 1 to 100

Legenda / Legend

- Spalliera / Back Cushions
  - Bracciolo / Armrest
  - Marmo / Marble
  - Poggiareni / Kidneyrest
  - Seduta / Seat Cushions
  - Aggancio Componibile / Connector
- ⊗ Lato terminale sempre rifinito e agganciabile agli elementi componibili / Terminal side is always finished and it can also be connected to modular elements

Note / Notes

Nicoline si riserva il diritto di apportare in ogni momento modifiche tecniche ed estetiche / Nicoline reserves the right to change, at any time and without prior warning, technical and aesthetic specifications of the articles.



# BRIC



frontale // front

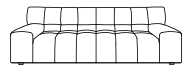

laterale // depth

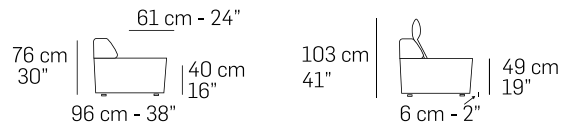

### Caratteristiche standard

- Struttura in legno e multistrato, molleggio seduta e schienale con cinghie elastiche.
- Imbottitura in poliuretano espanso ecologico a cellula aperta con densità differenziate, rivestito da falda di Tecnoform accoppiata al rivestimento esterno.
- Rivestimento in pelle o tessuto. Tutti i rivestimenti sono fissi.
- Piedi in materiale termoplastico nero.
- Inserimento letto non possibile.
- Lato componibile rifinito.

### Caratteristiche optional su richiesta con maggiorazione

- Vassoio sopra bracciolo in plexiglass trasparente.
- Poggiatesta (Cod.9900) con struttura in metallo e imbottitura in poliuretano espanso ecologico a cellula aperta.
- Per il multi rivestimento il prezzo va incrementato del 7%. Per maggiori dettagli fare riferimento al paragrafo "NOTE" posto nelle prime pagine del listino.

### Note

- Non è possibile applicare cuciture sui rivestimenti in pelle e tessuto.

### Standard features

- Frame: wooden structure, seat suspensions in reinforced elastic webbing.
- Padding in eco-friendly open cell polyurethane foam, with different densities, covered with a Tecnoform layer.
- Covering in leather or fabric. Not removable coverings.
- Legs in black thermoplastic material.
- No bed version available.
- Finished sectional sides.

### Optional features with upcharge

- Plexiglass armrest tray.
- Headrest (Cod.9900) with metal structure and padding in eco-friendly open cell polyurethane foam.
- 7% upcharge for combined coverings. Please refer to the notes at the beginning of pricelist.

### Notes

- No stitchings available for leather or fabric.

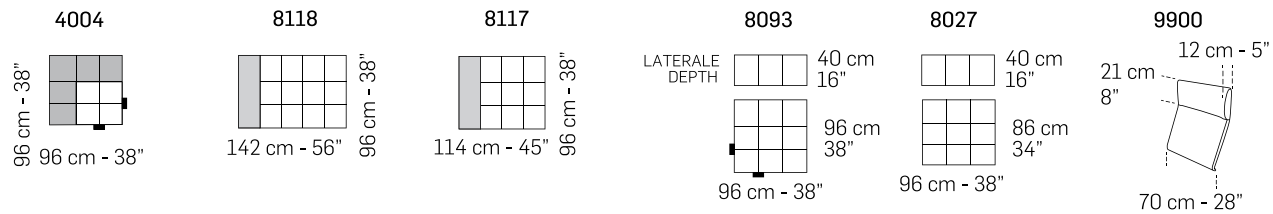
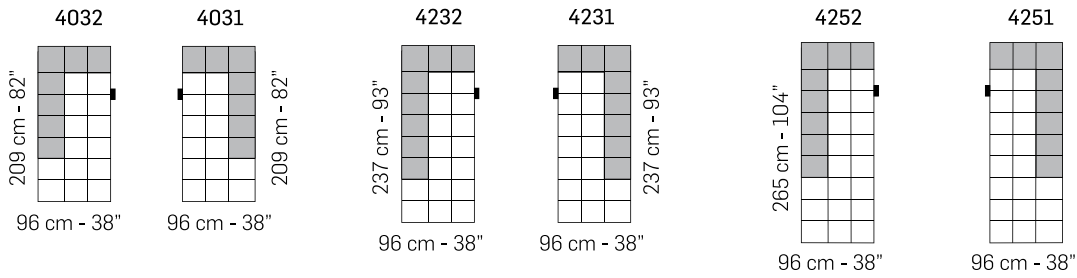
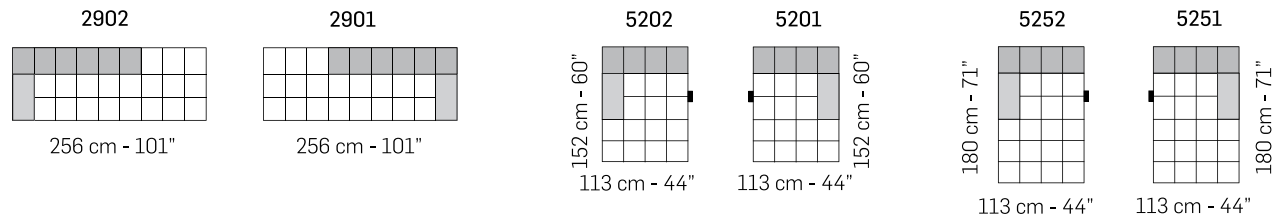
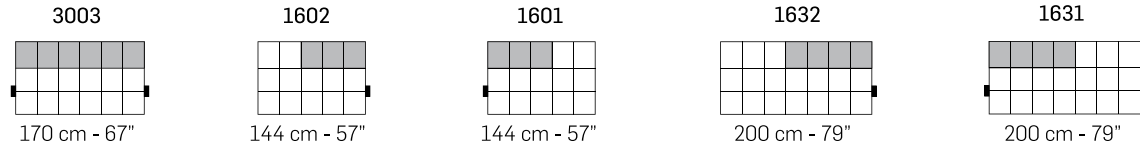
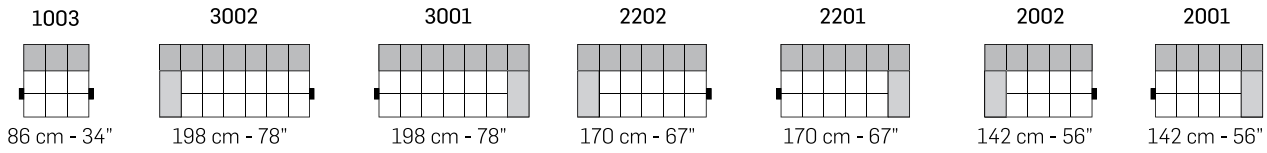
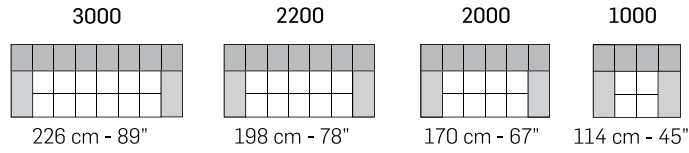

COMPOSIZIONI CONSIGLIATE / SUGGESTED COMPOSITIONS

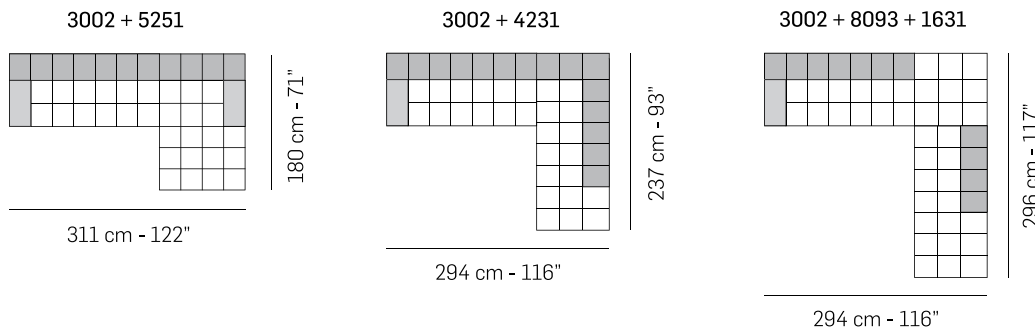

Scala 1:100  
 Ratio 1 to 100

Legenda / Legend

- Spalliera / Back Cushions
- Bracciolo / Armrest
- Aggancio Componibile / Connector
- Poggiareni / Kidneyrest
- Seduta / Seat Cushions

Note / Notes

Nicoline si riserva il diritto di apportare in ogni momento modifiche tecniche ed estetiche / Nicoline reserves the right to change, at any time and without prior warning, technical and aesthetic specifications of the articles.

# CADORNA

design application N° 402018000002313



frontale // front

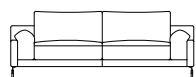

laterale // depth

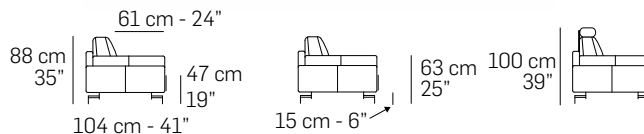

## Caratteristiche standard

- Struttura in legno e multistrato con supporto in metallo, molleggio seduta con cinghie elastiche.
- Cuscini di seduta in poliuretano espanso ecologico a cellula aperta con densità differenziate, rivestito da un materassino in piuma.
- Cuscini di spalliera e bracciolo in fibra "Extra soft" con inserto in poliuretano espanso ecologico a cellula aperta.
- Rivestimento in pelle o tessuto con cuscini di seduta, spalliera e braccioli sfoderabili.
- Solo per il mercato ITALIA il rivestimento in tessuto è completamente sfoderabile.
- Piedi in metallo Lucido (Cod.30), Satinato (Cod.31), Canna di fucile (Cod.50), Ottone satinato (Cod.51), Bronzo anticato (Cod.52).
- Elementi Cod.1421 - 1422 - 1471 - 1472 - 1671 - 1672 - 1731 - 1732 - 2341 - 2342 - 2371 - 2372 - 3031 - 3032 - 3051 - 3052 con ripiano in marmo Emperador (Cod.EM) oppure marmo Bianco Carrara (Cod.CA).
- Cucitura Cod.03 per rivestimento in pelle e tessuto.
- Inserimento letto non possibile.
- Lato componibile rifinito.

## Caratteristiche optional senza maggiorazione

- Disponibile con cucitura a contrasto, per la scelta del colore fare riferimento ai codici del campionario pelli.

## Caratteristiche optional su richiesta con maggiorazione

- Tavolino terminale (Cod.9503) fissato alla struttura e con ripiano in marmo Emperador (Cod.EM) oppure marmo Bianco Carrara (Cod.CA), disponibile per gli elementi Cod.1041 - 1042 - 1091 - 1092 - 1661 - 1662 - 1841 - 1842 - 5253.
- Poggiatesta (Cod.9900) con imbottitura in poliuretano espanso e supporto in metallo rivestito.
- Per il multi rivestimento il prezzo va incrementato del 7%. Per maggiori dettagli fare riferimento al paragrafo "NOTE" posto nelle prime pagine del listino.

## Note

- I disegni grafici che riportano l'asterisco (\*) sono sempre con lato rifinito e anche agganciabili agli elementi componibili.
- Non è possibile applicare altre cuciture.
- Per alcuni tessuti e velluti l'azienda si riserverà di applicare la cucitura Cod.00/ Cod.03 (vedi immagine).

## Standard features

- Frame: wooden structure with metal support, seat suspensions in reinforced elastic webbing.
- Seat cushions in eco-friendly open cell polyurethane foam, with different densities, covered with a mixed feather layer.
- Back and arm cushions in "Extra soft" fiber with eco-friendly open cell polyurethane foam.
- Covering in leather or fabric. Seat, back and armrest cushions coverings removable.
- Legs in Shiny metal (Cod.30), Satin (Cod.31), Gunmetal (Cod.50), Satin brass (Cod.51), Antique bronze (Cod.52).
- Versions Cod.1421- 1422- 1471- 1472- 1671 - 1672 - 1731 - 1732 - 2341- 2342- 2371- 2372 - 3031- 3032- 3051- 3052 with top in marble Emperador (Cod.EM) or White Carrara marble (Cod.CA).
- Stitching type Cod.03 for leather and fabric coverings.
- No bed version available.
- Sectional sides finished.

## Optional features without any upcharge

- Contrast stitching available. Please refer to our leather collection for a thread color indication.

## Optional features with upcharge

- Terminal table (Cod.9503) attached to the frame, with the top available in Emperador marble (Cod.EM) or White Carrara marble (Cod.CA) on versions Cod.1041 - 1042 - 1091 - 1092 - 1661 - 1662 - 1841 - 1842 - 5253.
- Headrest (Cod.9900) with padding in open cell polyurethane foam and covered metal structure.
- 7% upcharge for combined coverings. Please refer to the notes at the beginning of pricelist.

## Notes

- Versions with asterisk (\*) have always the finished terminal side with the possibility to be connected to modular elements.
- Different stitchings not available.
- For some fabrics and velvets production dept. must apply the stitching Cod.00/ Cod.03 (as per picture below).



Piede in metallo // Metal legs



Metallo Lucido (Cod.30) // Shiny Metal (Cod.30)



Metallo Satinato (Cod.31) // Satin Metal (Cod.31)



Canna di Fucile (Cod.50) // Gunmetal (Cod.50)



Ottone Satinato (Cod.51) // Satin Brass (Cod.50)



Bronzo Anticato (Cod.52) // Antique Bronze (Cod.52)



Elementi // Versions



Marmo Emperador (Cod.EM) // Emperador marble (Cod.EM)



Marmo Bianco Carrara (Cod.CA) // White Carrara marble (Cod.CA)

Cuciture // Stitching



Cod.00

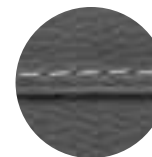

Cod.03





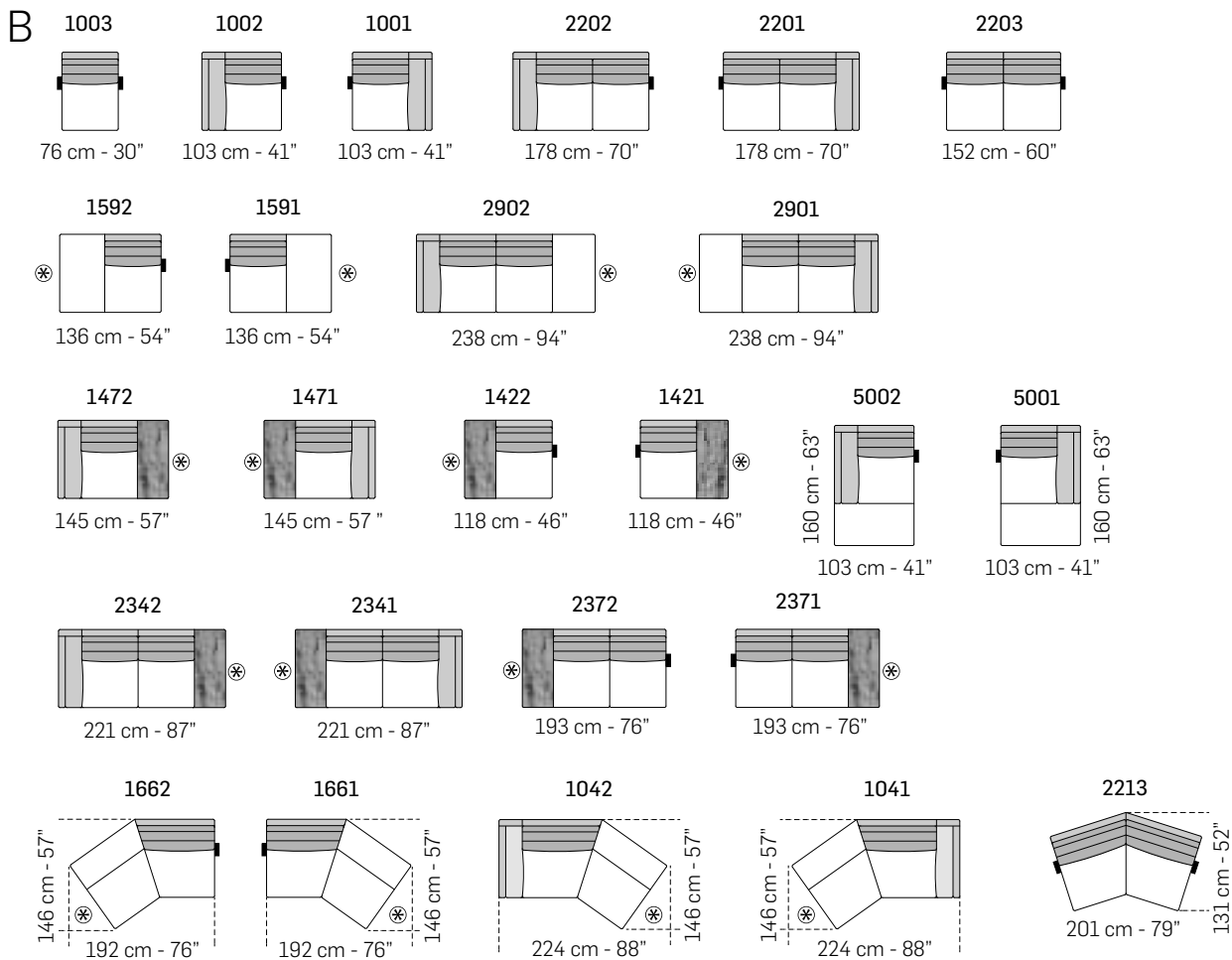

tutti gli elementi del gruppo B hanno lo stesso modulo di seduta - all items in group B have the same seat width

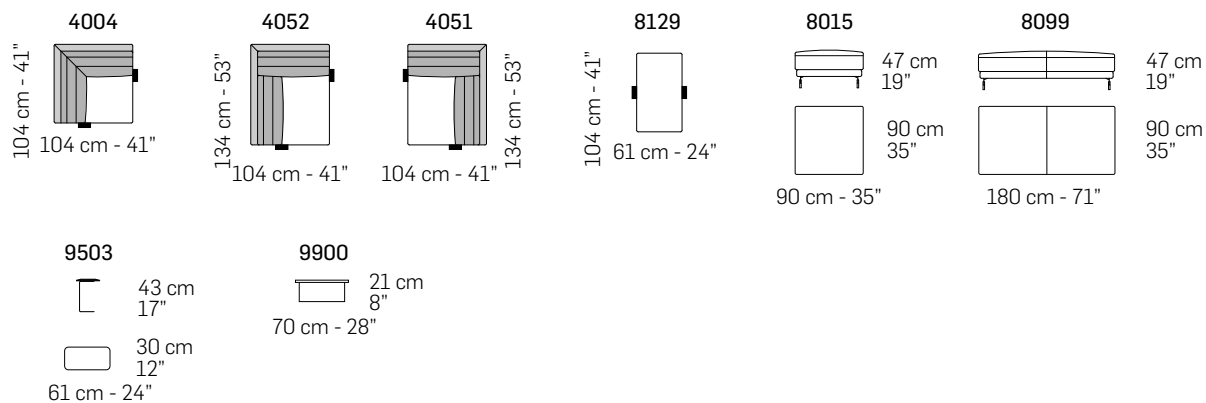

COMPOSIZIONI CONSIGLIATE / SUGGESTED COMPOSITIONS

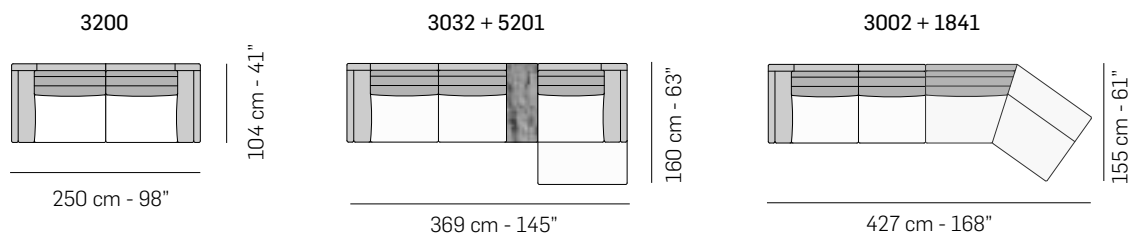

Scala 1:100  
Ratio 1 to 100

Legenda / Legend

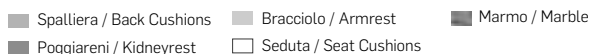

⊗ Lato terminale sempre rifinito e agganciabile agli elementi componibili / Terminal side is always finished and it can also be connected to modular elements

Note / Notes

Nicoline si riserva il diritto di apportare in ogni momento modifiche tecniche ed estetiche / Nicoline reserves the right to change, at any time and without prior warning, technical and aesthetic specifications of the articles.



# CAIROLI

design application N° 402019000000467

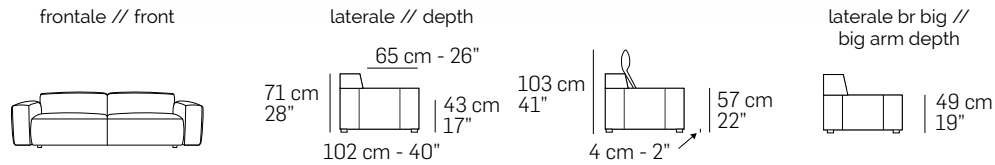

## Caratteristiche standard

- Struttura in legno e multistrato, molleggio seduta con cinghie elastiche.
- Imbottitura in poliuretano espanso ecologico a cellula aperta con densità differenziate, rivestito da un materassino in misto piuma.
- Rivestimento in pelle o tessuto. Tutti i rivestimenti sono fissi.
- Solo per il mercato ITALIA il rivestimento in tessuto è completamente sfoderabile.
- Piedi in materiale termoplastico nero.
- (\*) Cucitura Cod.04 per rivestimento in pelle e tessuto.
- Cucitura Cod.06 sulla parte superiore della seduta e parte posteriore bracciolo solo per rivestimento in pelle.
- Inserimento letto non possibile.
- Lato componibile rifinito.
- Per tutte le versioni in tessuto sfoderabile i braccioli sono removibili con sistema a baionetta.

## Caratteristiche optional su richiesta senza maggiorazione

- Disponibile con cucitura a contrasto, per la scelta del colore fare riferimento ai codici del campionario pelli.

## Caratteristiche optional su richiesta con maggiorazione

- Poggiatesta (Cod.9900) con imbottitura in poliuretano espanso e supporto in metallo rivestito.
- Per il multi rivestimento il prezzo va incrementato del 7%. Per maggiori dettagli fare riferimento al paragrafo "NOTE" posto nelle prime pagine del listino.

## Note

- (\*) Non è possibile realizzare il rivestimento con pelli di spessore maggiore di 1.8 mm, tra cui l'articolo Nobile.
- Gli elementi Cod.6021 - 6022 sono versioni singole che non possono essere agganciate ad un elemento componibile.
- I disegni grafici che riportano l'asterisco (\*) sono sempre con lato rifinito e anche agganciabili agli elementi componibili.

## Standard features

- Frame: wooden structure, seat suspensions in reinforced elastic webbing.
- Padding in eco-friendly open cell polyurethane foam, with different densities, covered with a mixed feather layer.
- Covering in leather or fabric. Not removable coverings.
- Legs in black thermoplastic material.
- (\*) Stitching type Cod.04 for leather and fabric coverings.
- Stitching type Cod.06 on the top part of the seat and the back part of the armrest only for leather covering.
- No bed version available.
- Sectional sides finished.
- Versions with removable fabric covering are equipped with bayonet connectors for armrests only.

## Optional features without any upcharge

- Contrast stitching available. Please refer to our leather collection for a thread color indication.

## Optional features with upcharge

- Headrest (Cod.9900) with padding in open cell polyurethane foam and covered metal structure.
- 7% upcharge for combined coverings. Please refer to the notes at the beginning of pricelist.

## Notes

- (\*) Covering not available with leathers thicker than 1.8 mm, such as leather Nobile.
- Versions Cod.6021 - 6022 are free-standing and cannot be attached to modular elements.
- Versions with asterisk (\*) have always the finished terminal side with the possibility to be connected to modular elements.

Cuciture //  
Stitching

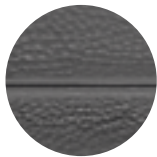

Cod.04

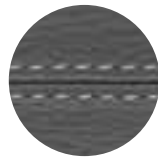

Cod.06

Poggiatesta //  
Headrest



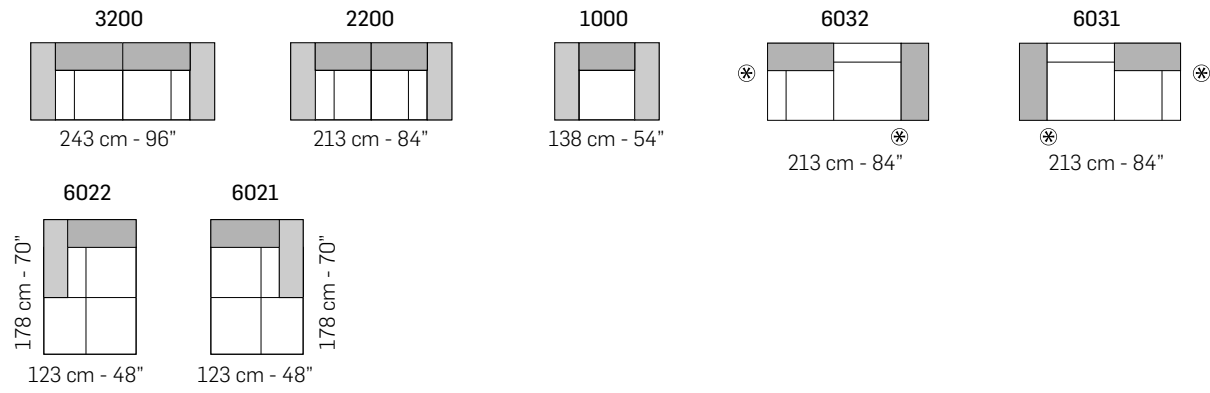

**A**

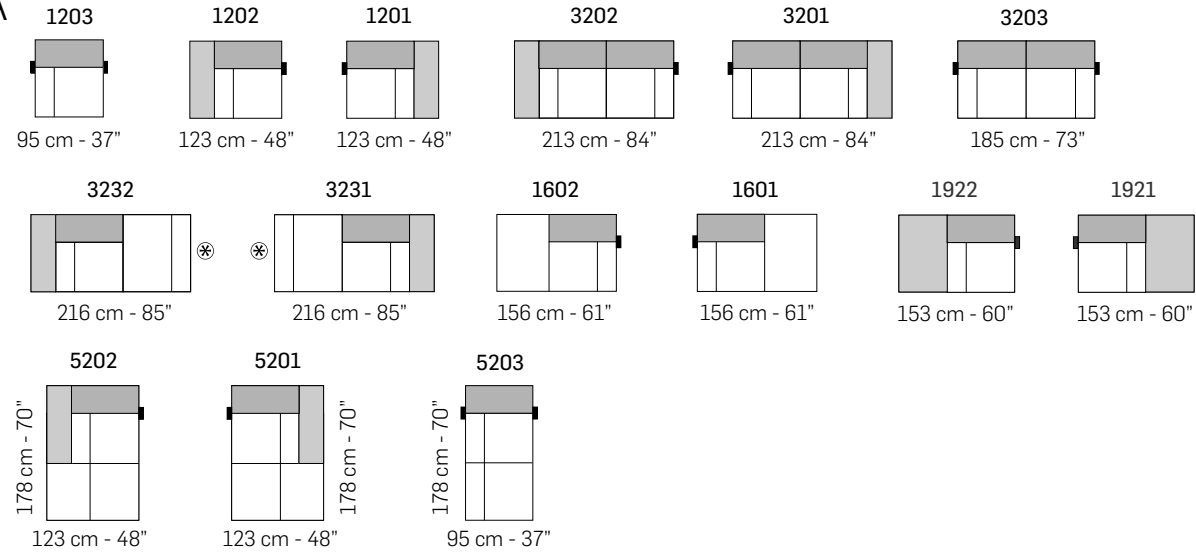

tutti gli elementi del gruppo A hanno lo stesso modulo di seduta - all items in group A have the same seat width

**B**

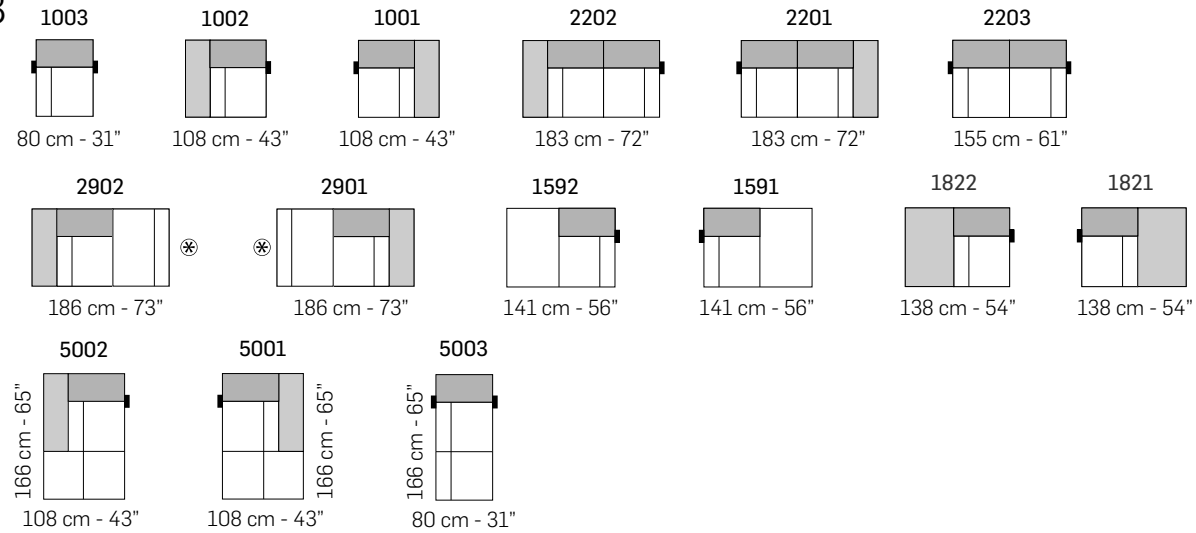

tutti gli elementi del gruppo B hanno lo stesso modulo di seduta - all items in group B have the same seat width

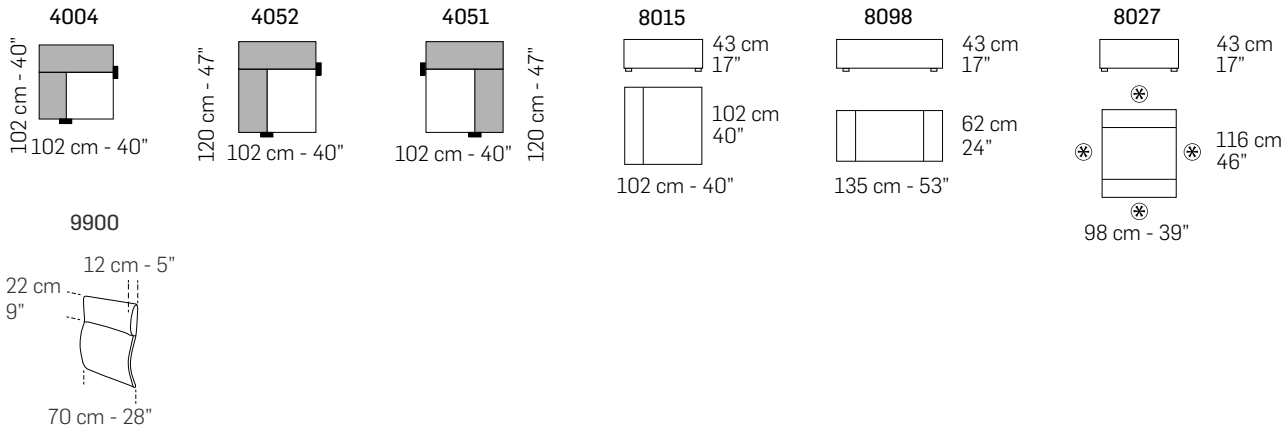

COMPOSIZIONI CONSIGLIATE / SUGGESTED COMPOSITIONS

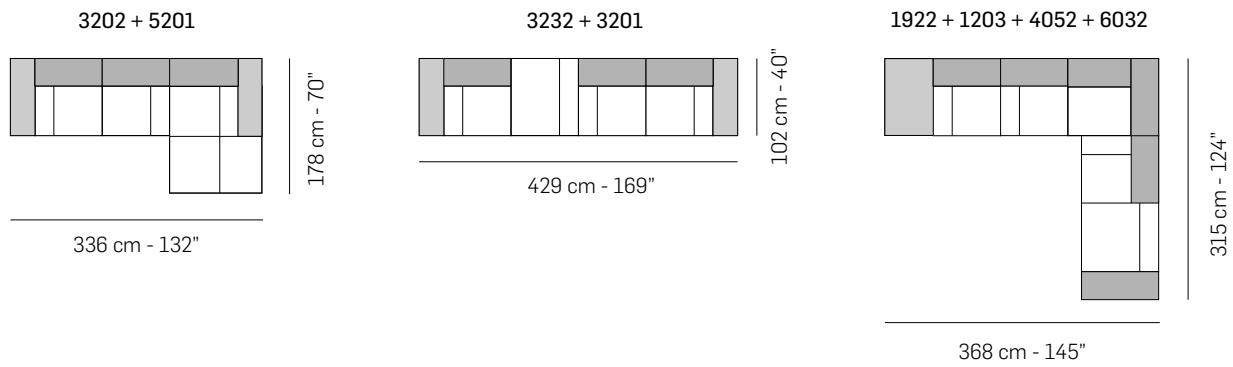

Scala 1:100  
Ratio 1 to 100

Legenda / Legend

- Spalliera / Back Cushions
- Bracciolo / Armrest
- Poggiareni / Kidneyrest
- Seduta / Seat Cushions
- ⊗ Lato terminale sempre rifinito e agganciabile agli elementi componibili / Terminal side is always finished and it can also be connected to modular elements
- Aggancio Componibile / Connector

Note / Notes

Nicoline si riserva il diritto di apportare in ogni momento modifiche tecniche ed estetiche / Nicoline reserves the right to change, at any time and without prior warning, technical and aesthetic specifications of the articles.



# CAIROLI DEEP



frontale // front

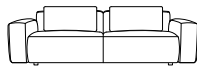

laterale // depth

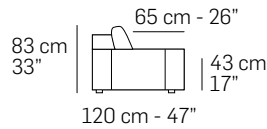

laterale br big //  
big arm depth

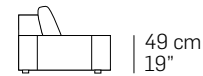
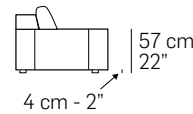

### Caratteristiche standard

- Struttura in legno e multistrato, molleggio seduta con cinghie elastiche.
- Imbottitura in poliuretano espanso ecologico a cellula aperta con densità differenziate, rivestito da un materassino in misto piuma.
- Cuscino di spalliera removibile in misto piuma.
- Rivestimento in pelle o tessuto. Tutti i rivestimenti sono fissi, con cuscino di spalliera sfoderabile.
- Solo per il mercato ITALIA il rivestimento in tessuto è completamente sfoderabile.
- Piedi in materiale termoplastico nero.
- (\*) Cucitura Cod.04 per rivestimento in pelle e tessuto.
- Cucitura Cod.06 sulla parte superiore della seduta e parte posteriore bracciolo solo per rivestimento in pelle.
- Inserimento letto non possibile.
- Lato componibile rifinito.
- Per tutte le versioni in tessuto sfoderabile i braccioli sono removibili con sistema a baionetta.

### Caratteristiche optional su richiesta senza maggiorazione

- Disponibile con cucitura a contrasto, per la scelta del colore fare riferimento ai codici del campionario pelli.

### Caratteristiche optional su richiesta con maggiorazione

- Per il multi rivestimento il prezzo va incrementato del 7%. Per maggiori dettagli fare riferimento al paragrafo "NOTE" posto nelle prime pagine del listino.
- Cuscino Cod.9011 e Cod.9015 realizzati con imbottitura in piuma.
- Ogni versione comprende un numero di cuscini di schienale pari a quanto riportato nello stesso schema (disegno versione). Eventuali cuscini supplementari potranno essere ordinati singolarmente. Vedi Cod.9011 e Cod.9015.

### Note

- (\*) Non è possibile realizzare il rivestimento con pelli di spessore maggiore di 1.8 mm, tra cui l'articolo Nobile.
- Gli elementi Cod.D6021 - D6022 sono versioni singole che non possono essere agganciate ad un elemento componibile.
- I disegni grafici che riportano l'asterisco (\*) sono sempre con lato rifinito e anche agganciabili agli elementi componibili.

### Standard features

- Frame: wooden structure, seat suspensions in reinforced elastic webbing.
- Padding in eco-friendly open cell polyurethane foam, with different densities, covered with a mixed feather layer.
- Back cushions with padding in mixed feather. Cushions are removable.
- Covering in leather or fabric. Not removable coverings except for back cushions coverings.
- Legs in black thermoplastic material.
- (\*) Stitching type Cod.04 for leather and fabric coverings.
- Stitching type Cod.06 on the top part of the seat and the back part of the armrest only for leather covering.
- No bed version available.
- Sectional sides finished.
- Versions with removable fabric covering are equipped with bayonet connectors for armrests only.

### Optional features without any upcharge

- Contrast stitching available. Please refer to our leather collection for a thread color indication.

### Optional features with upcharge

- 7% upcharge for combined coverings. Please refer to the notes at the beginning of pricelist.
- Cushion Cod. 9011 and 9015 made with feather padding.
- Each version includes a certain number of back cushions as shown in the version drawing. Any additional cushions can be ordered individually. Please consider cushions cod.9011 and Cod.9015.

### Notes

- (\*) Covering not available with leathers thicker than 1.8 mm, such as leather Nobile.
- Versions Cod.D6021 - D6022 are free-standing and cannot be attached to modular elements.
- Versions with asterisk (\*) have always the finished terminal side with the possibility to be connected to modular elements.

Cuciture //  
Stitching

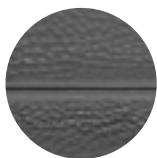

Cod.04

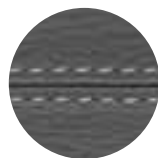

Cod.06

Poggiatesta //  
Headrest





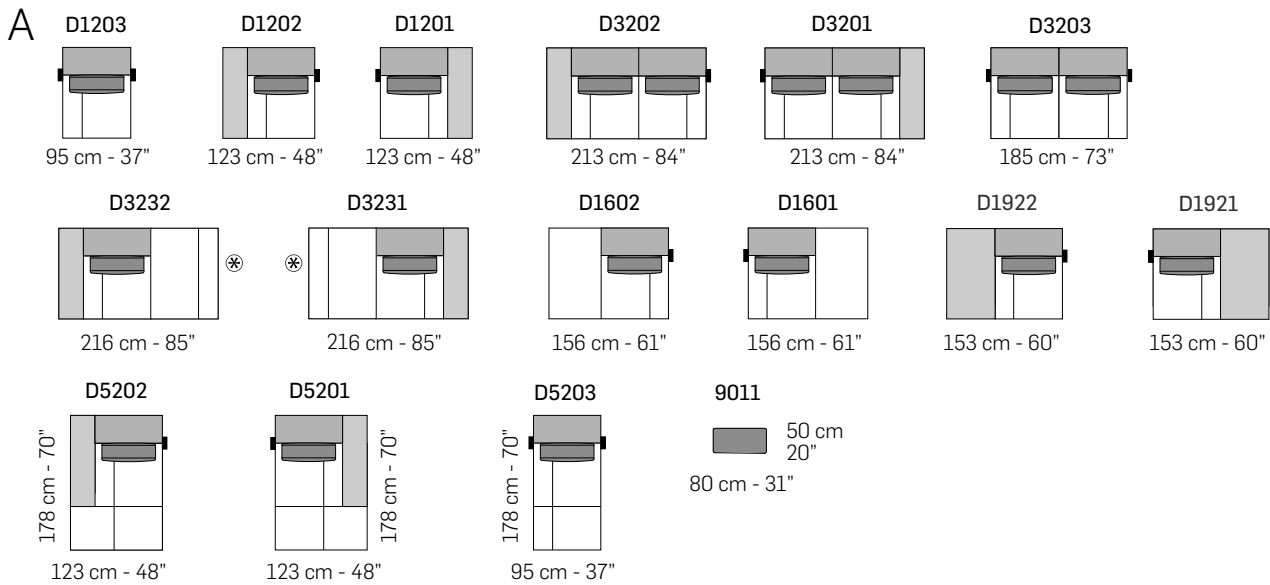
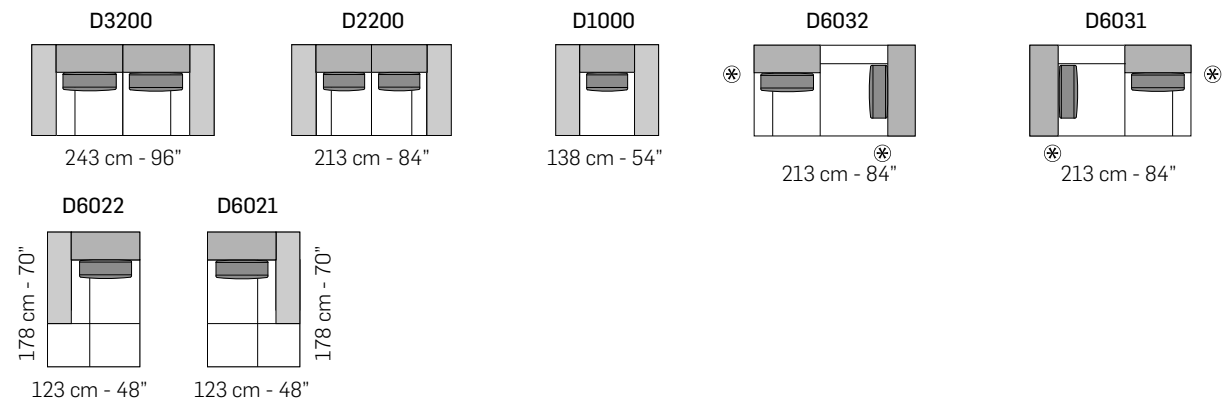

tutti gli elementi del gruppo A hanno lo stesso modulo di seduta - all items in group A have the same seat width

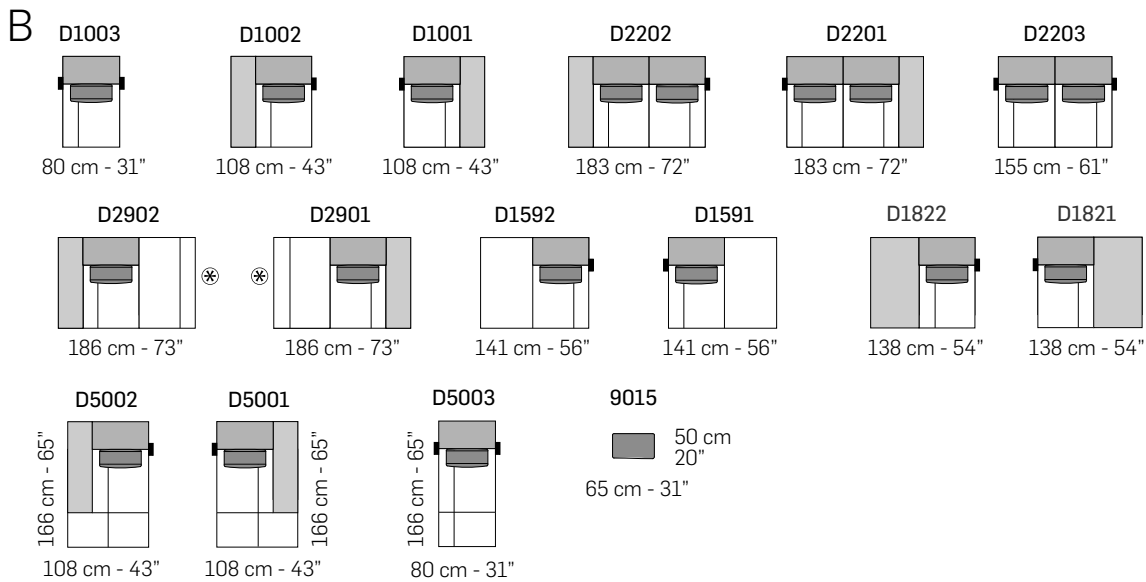

tutti gli elementi del gruppo B hanno lo stesso modulo di seduta - all items in group B have the same seat width

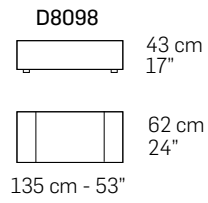
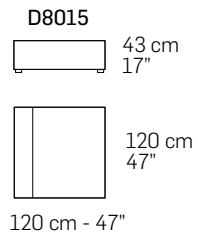
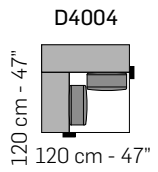

COMPOSIZIONI CONSIGLIATE / SUGGESTED COMPOSITIONS

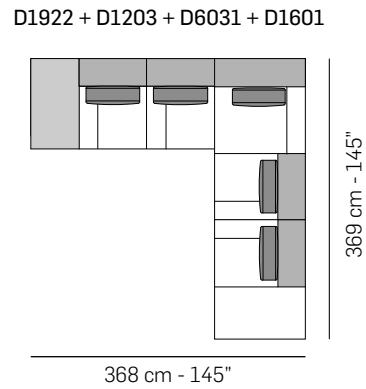
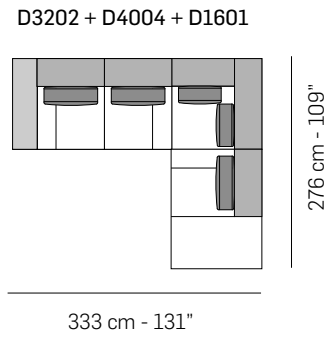
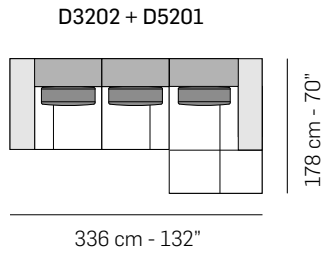

Scala 1:100  
Ratio 1 to 100

Legenda / Legend

- Spalliera / Back Cushions
- Bracciolo / Armrest
- Poggiareni / Kidneyrest
- Seduta / Seat Cushions

⊗ Lato terminale sempre rifinito e agganciabile agli elementi componibili / Terminal side is always finished and it can also be connected to modular elements

■ Aggancio Componibile / Connector

Note / Notes

Nicoline si riserva il diritto di apportare in ogni momento modifiche tecniche ed estetiche / Nicoline reserves the right to change, at any time and without prior warning, technical and aesthetic specifications of the articles.



# CRUMBLE

Design Application N° 40202200001046

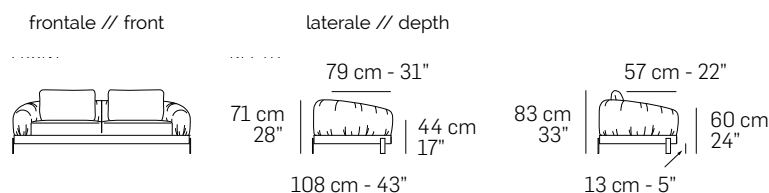
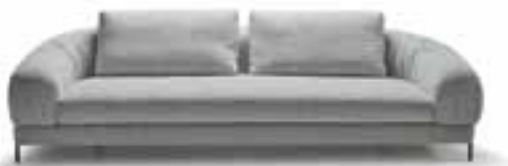

## Caratteristiche standard

- Struttura in multistrato, massello di abete e molleggio seduta con cinghie elastiche.
- Imbottiture in poliuretano espanso ecologico a cellula aperta con densità differenziate.
- Cuscini di schienale in fibra "Extra soft".
- Rivestimento in pelle o tessuto con cuscini di seduta e spalliera sfoderabili.
- Elementi Cod.1421 - 1422 - 1671 - 1672 - 3031 - 3032 - 9506 - 9507 con ripiano in marmo Bianco Carrara (Cod.CA).
- Piede in metallo Canna di fucile (Cod.50), Ottone satinato (Cod.51), Bronzo anticato (Cod.52).
- Cucitura Cod.01 per il rivestimento in pelle.
- Il rivestimento in tessuto non possiede cuciture.
- Inserimento letto non possibile.
- Lato componibile rifinito.

## Caratteristiche optional su richiesta senza maggiorazione

- Nessuna maggiorazione in caso di scelta dei soli cuscini schienale con rivestimento differente da quello principale.
- Disponibile con cucitura a contrasto, per la scelta del colore fare riferimento ai codici del campionario pelli.

## Caratteristiche optional su richiesta con maggiorazione

- Per il multi rivestimento il prezzo va incrementato del 7%, ad eccezione di quanto riportato nel paragrafo "senza maggiorazione". Per maggiori dettagli fare riferimento al paragrafo "NOTE" posto nelle prime pagine del listino.
- Elementi Cod.1421 - 1422 - 1671 - 1672 - 3031 - 3032 - 9506 - 9507 con ripiano in marmo Emperador (Cod.EM), Nero Marquinia (Cod.NM).

## Note

- I disegni grafici che riportano l'asterisco (\*) sono sempre con lato rifinito e anche agganciabili agli elementi componibili.
- Non è possibile applicare altre cuciture.

## Standard features

- Frame: wooden structure, solid fir wood and seat suspensions in reinforced elastic webbing.
- Paddings in eco-friendly open cell polyurethane foam, with different densities.
- Back cushions in "Extra soft" fiber.
- Covering in leather or fabric. Seat and back cushions coverings removable.
- Versions Cod.1421 - 1422 - 1671 - 1672 - 3031 - 3032 - 9506 - 9507 with top in White Carrara marble (Cod.CA).
- Legs in Gunmetal (Cod.50), Satin Brass (Cod.51), Antique bronze (Cod.52).
- Stitching type Cod.01 for leather covering.
- No stitchings for fabric covering.
- No bed version available.
- Sectional sides finished.

## Optional features available upon request without any upcharge

- No upcharge in case of back cushions only with different covering from the primary one.
- Stitching, unless differently requested, will be matching the leather or fabric colour. Contrast stitching colour can be ordered at no extra charge. You might use as reference any Nicoline leather.

## Optional features available upon request with an upcharge

- 7% upcharge for combined coverings, except as indicated in the paragraph "without any upcharge". Please refer to the notes at the beginning of pricelist.
- Versions Cod.1421 - 1422 - 1671 - 1672 - 3031 - 3032 - 9506 - 9507 with top in marble Emperador (Cod.EM), Black Marquinia marble (Cod.NM).

## Notes

- Versions with asterisk (\*) have always the finished terminal side with the possibility to be connected to modular elements.
- Different stitchings not available.



Canna di Fucile (Cod.50) //  
Gunmetal (Cod.50)



Ottone Satinato (Cod.51) //  
Satin Brass (Cod.51)



Bronzo Anticato (Cod.52) //  
Antique Bronze (Cod.52)

Cuciture //  
Stitching

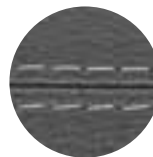

Cod.01

Piede in metallo //  
Metal legs

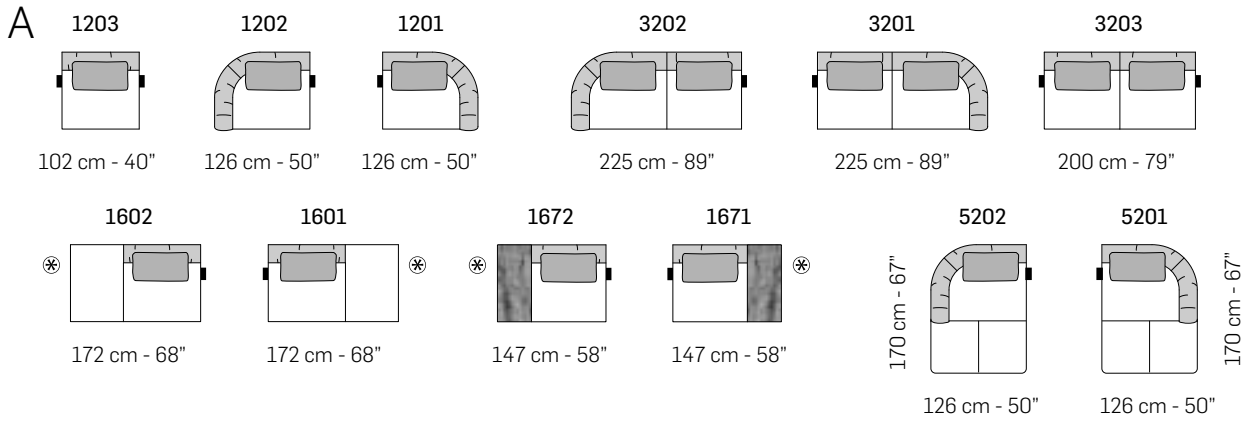
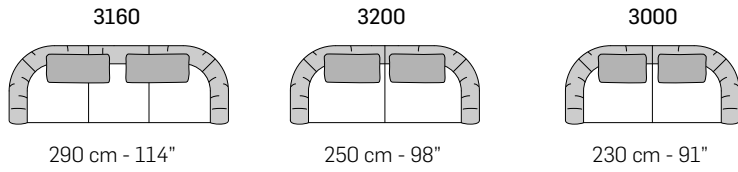

tutti gli elementi del gruppo A hanno lo stesso modulo di seduta - all items in group A have the same seat width

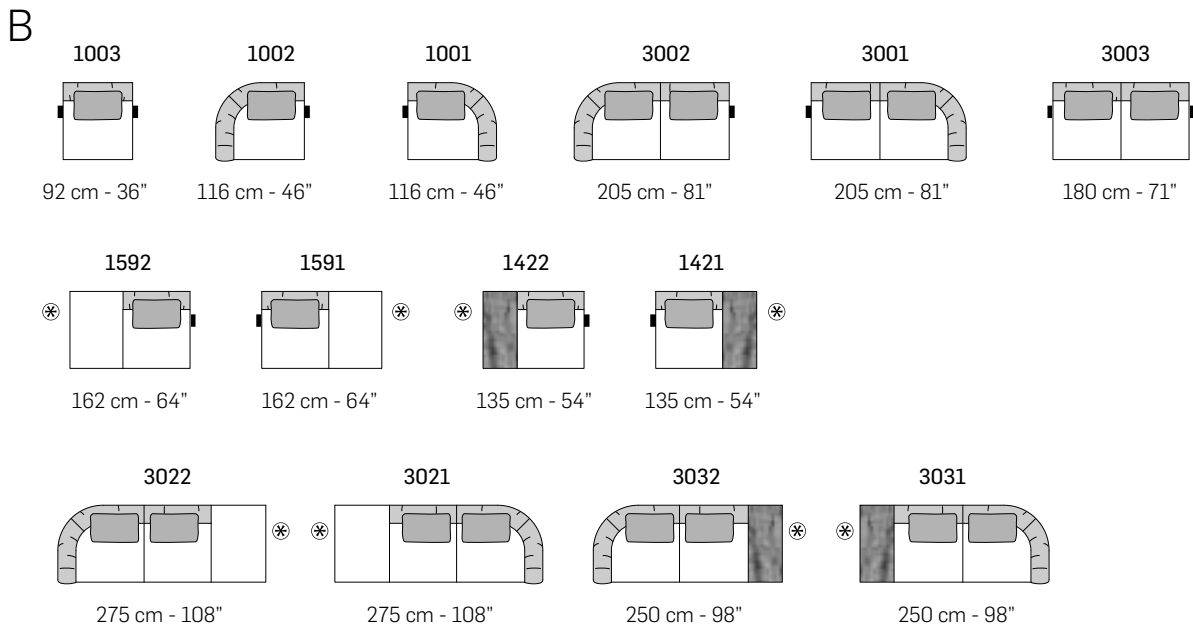

tutti gli elementi del gruppo B hanno lo stesso modulo di seduta - all items in group B have the same seat width

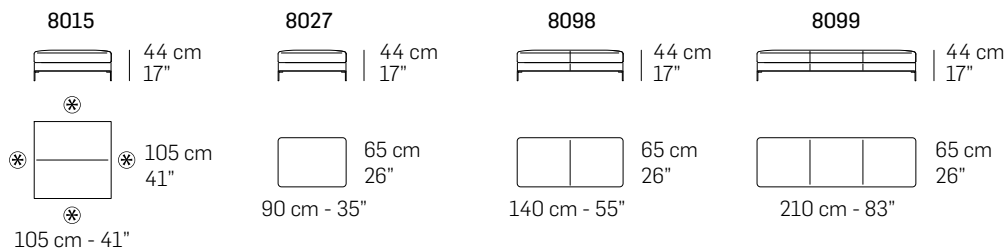
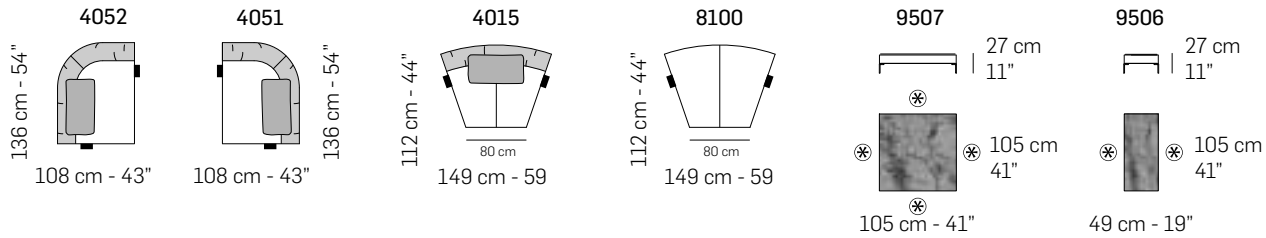
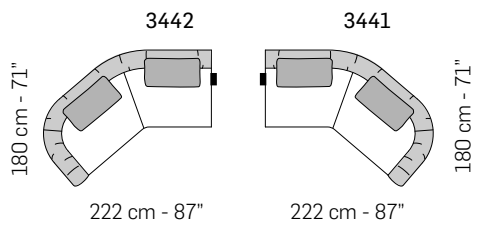

CUSCINETTI CONSIGLIATI / SUGGESTED PILLOWS

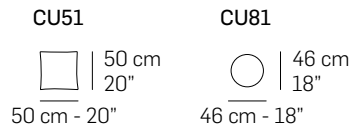

COMPOSIZIONI CONSIGLIATE / SUGGESTED COMPOSITIONS

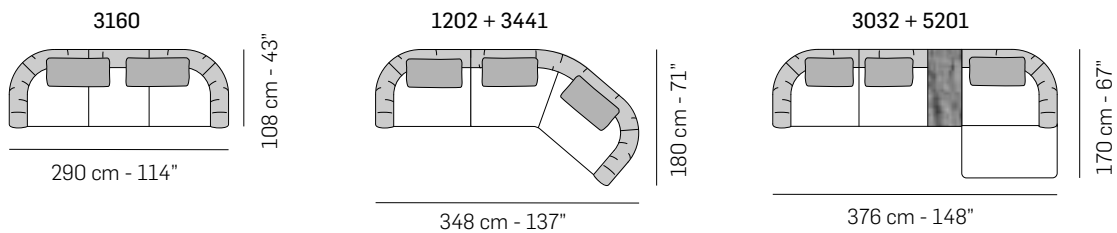

Scala 1:100  
Ratio 1 to 100

Legenda / Legend

- Spalliera / Back Cushions
- Bracciolo / Armrest
- Marmo / Marble
- Poggiareni / Kidneyrest
- Seduta / Seat Cushions
- Aggancio Componibile / Connector

Note / Notes

Nicoline si riserva il diritto di apportare in ogni momento modifiche tecniche ed estetiche / Nicoline reserves the right to change, at any time and without prior warning, technical and aesthetic specifications of the articles.



# EGEO

Design Application N° 402017000039849

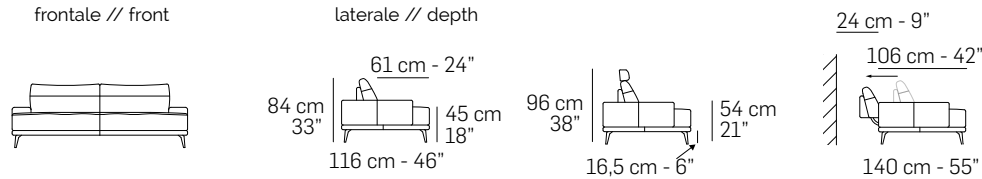

### Caratteristiche standard

- Struttura in legno e multistrato, molleggio seduta con cinghie elastiche.
- Imbottiture in poliuretano espanso ecologico a cellula aperta con densità differenziate.
- Rivestimento in pelle o tessuto. Tutti i rivestimenti sono fissi.
- Rivestimento in pelle con seduta trapuntata.
- Rivestimento in tessuto con seduta senza trapuntatura.
- Piede in metallo Lucido (Cod.30), Satinato (Cod.31), Canna di fucile (Cod.50), Bronzo anticato (Cod.52).
- I cuscini di schienale sono dotati di meccanismo "pendular".
- Cucitura Cod.03 per rivestimento in tessuto.
- Cucitura Cod.07 per rivestimento in pelle.
- Inserimento letto non possibile.
- Lato componibile non rifinito.

### Caratteristiche optional su richiesta senza maggiorazione

- Disponibile con cucitura a contrasto, per la scelta del colore fare riferimento ai codici del campionario pelli.

### Caratteristiche optional su richiesta con maggiorazione

- Solo per le versioni dove previsto, il lato componibile può essere rifinito
- Poggiatesta (Cod.9900) con imbottitura in poliuretano espanso ecologico a cellula aperta e rivestimento sfoderabile.
- Per il multi rivestimento il prezzo va incrementato del 7%. Per maggiori dettagli fare riferimento al paragrafo "NOTE" posto nelle prime pagine del listino.

### Note

- Non è possibile applicare altre cuciture.
- Per alcuni tessuti e velluti l'azienda si riserva di applicare la cucitura Cod.00 / Cod.03 (vedi immagine).

### Standard features

- Frame: wooden structure, seat suspensions in reinforced elastic webbing.
- Paddings in eco-friendly open cell polyurethane foam with different densities.
- Covering in leather or fabric. Not removable coverings.
- Quilted seat for leather coverings.
- Not quilted seat for fabric coverings.
- Legs in Shiny metal (Cod.30), Satin metal (Cod.31), Gunmetal (Cod.50), Antique bronze (Cod.52).
- Back cushion with pendular mechanism on all elements.
- Stitching type Cod.03 for fabric coverings.
- Stitching type Cod.07 for leather coverings.
- No bed version available.
- Sectional sides not finished.

### Optional features without any upcharge

- Contrast stitching available. Please refer to our leather collection for a thread color indication.

### Optional features with upcharge

- Sectional sides finished (if possible).
- Headrest (Cod.9900) in eco-friendly open cell polyurethane foam and removable covering.
- 7% upcharge for combined coverings. Please refer to the notes at the beginning of pricelist.

### Notes

- Different stitchings not available.
- For some fabrics and velvets production dept. must apply the stitching Cod.00 / Cod.03 (as per picture below).



Piede in metallo // Metal legs

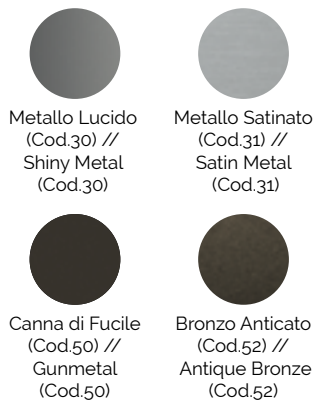

Cuciture // Stitching

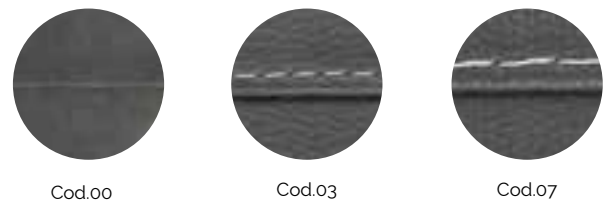



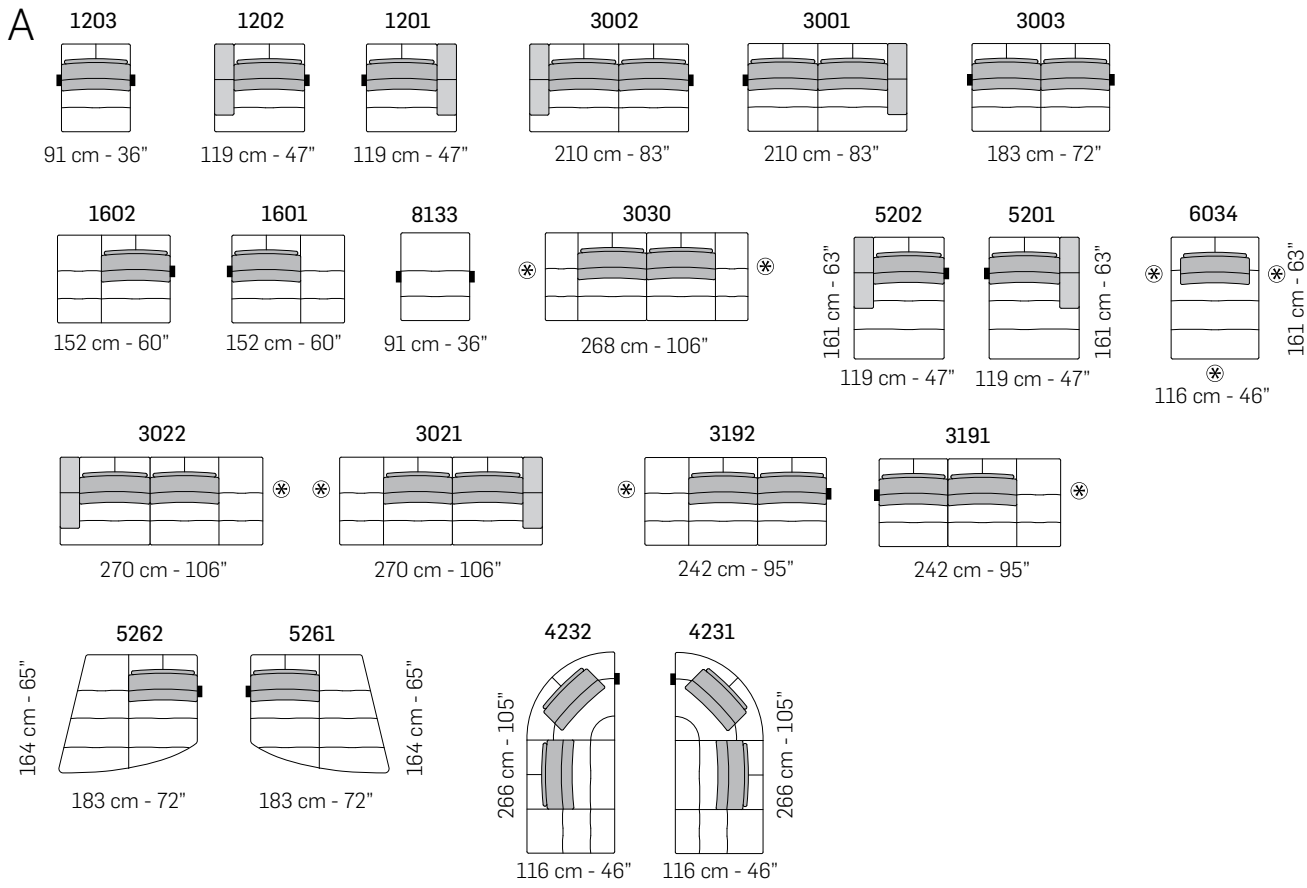
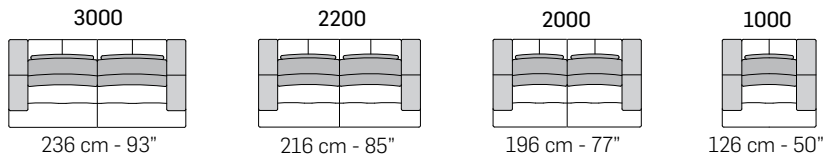

tutti gli elementi del gruppo A hanno lo stesso modulo di seduta - all items in group A have the same seat width



COMPOSIZIONI CONSIGLIATE / SUGGESTED COMPOSITIONS

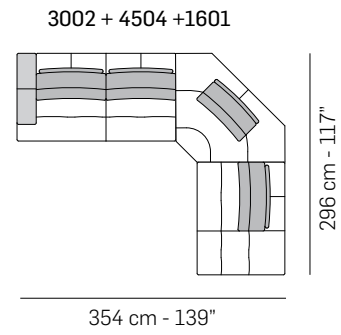
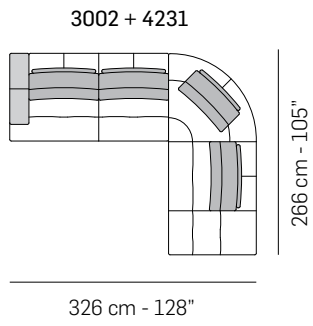
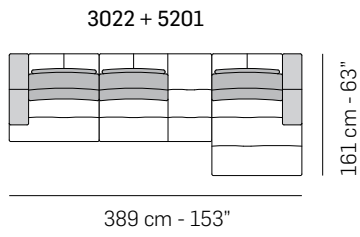

Scala 1:100  
Ratio 1 to 100

Legenda / Legend

■ Spalliera / Back Cushions    ■ Bracciolo / Armrest  
■ Poggiareni / Kidneyrest    □ Seduta / Seat Cushions

⊗ Lato terminale sempre rifinito e agganciabile agli elementi componibili / Terminal side is always finished and it can also be connected to modular elements

■ Aggancio Componibile / Connector

Note / Notes

Nicoline si riserva il diritto di apportare in ogni momento modifiche tecniche ed estetiche / Nicoline reserves the right to change, at any time and without prior warning, technical and aesthetic specifications of the articles.

# GARY

Design Application N° 008642821-0007



frontale // front

laterale // depth

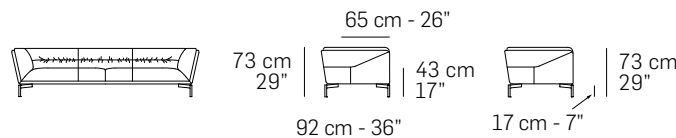

## Caratteristiche standard

- Struttura in multistrato, massello di abete e base in MDF con rinforzi in metallo, molleggio seduta con cinghie elastiche.
- Imbottiture in poliuretano espanso ecologico a cellula aperta con densità differenziate.
- Rivestimento in pelle o tessuto. Tutti i rivestimenti sono fissi.
- Piede in metallo Canna di fucile (Cod.50), Ottone satinato (Cod.51), Bronzo anticato (Cod.52).
- Elementi Cod.1421 - 1422 - 1671 - 1672 - 3031 - 3032 - 3521 - 3522 - 9507 con ripiano in marmo Bianco Carrara (Cod.CA).
- Le cuciture per il rivestimento in pelle sono realizzate nel seguente modo: Cucitura Cod.03 per parte perimetrale interna; Cucitura Cod.01 per la restante parte.
- Il rivestimento in tessuto possiede solamente la cucitura Cod.03.
- Inserimento letto non possibile.
- Lato componibile rifinito.

## Caratteristiche optional su richiesta senza maggiorazione

- Disponibile con cucitura a contrasto, per la scelta del colore fare riferimento ai codici del campionario pelli.

## Caratteristiche optional su richiesta con maggiorazione

- Per il multi rivestimento il prezzo va incrementato del 7%. Per maggiori dettagli fare riferimento al paragrafo "NOTE" posto nelle prime pagine del listino.
- Elementi Cod.1421 - 1422 - 1671 - 1672 - 3031 - 3032 - 3521 - 3522 - 9507 con ripiano in marmo Emperador (Cod.EM), Nero Marquinia (Cod.NM).

## Note

- I disegni grafici che riportano l'asterisco (\*) sono sempre con lato rifinito e anche agganciabili agli elementi componibili
- Non è possibile applicare altre cuciture.
- Per alcuni tessuti e velluti l'azienda si riserva di applicare la cucitura Cod.00 / Cod.03 (vedi immagine).

## Standard features

- Frame: wooden structure, solid fir wood with MDF base with metal reinforcements, seat suspensions in reinforced elastic webbing.
- Paddings in eco-friendly open cell polyurethane foam, with different densities.
- Covering in leather or fabric. Not removable coverings.
- Metal legs in Gunmetal (Cod.50), Satin Brass (Cod.51), Antique bronze (Cod.52).
- Versions Cod.1421- 1422- 1671- 1672- 3031- 3032- 3521- 3522 - 9507 with top in White Carrara marble (Cod.CA).
- Stitchings only for leather covering are being placed as per the following: Stitching type Cod.03 for the inner perimeter part; Stitching type Cod.01 for the remaining part.
- Stitching type Cod.03 only for fabric covering.
- No bed version available.
- Sectional sides finished.

## Optional features available upon request without any upcharge

- Stitching, unless differently requested, will be matching the leather or fabric colour. Contrast stitching colour can be ordered at no extra charge. You might use as reference any Nicoline leather.

## Optional features available upon request with an upcharge

- 7% upcharge for combined coverings. Please refer to the notes at the beginning of pricelist.
- Versions Cod.1421- 1422- 1671- 1672- 3031- 3032- 3521- 3522 - 9507 with top in Emperador marble (Cod.EM), Black Marquinia marble (Cod.NM).

## Notes

- Versions with asterisk (\*) have always the finished terminal side with the possibility to be connected to modular elements.
- Different stitchings not available.
- For some fabrics and velvets production dept. must apply the stitching Cod.00 / Cod.03 (as per picture below).



Piede in metallo // Metal legs



Canna di Fucile (Cod.50) // Gunmetal (Cod.50)



Ottone Satinato (Cod.51) // Satin Brass (Cod.51)



Bronzo Anticato (Cod.52) // Antique Bronze (Cod.52)



Elementi // Versions



Marmo Bianco Carrara (Cod.CA) // Withe Carrara marble (Cod.CA)



Marmo Emperador (Cod.EM) // Emperador marble (Cod.EM)



Marmo Nero Marquinia (Cod.NM) // Black Marquinia marble (Cod.NM)

Cuciture // Stitching



Cod.00

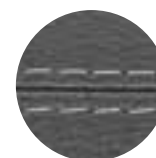

Cod.01

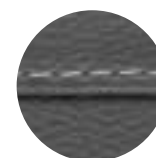

Cod.03

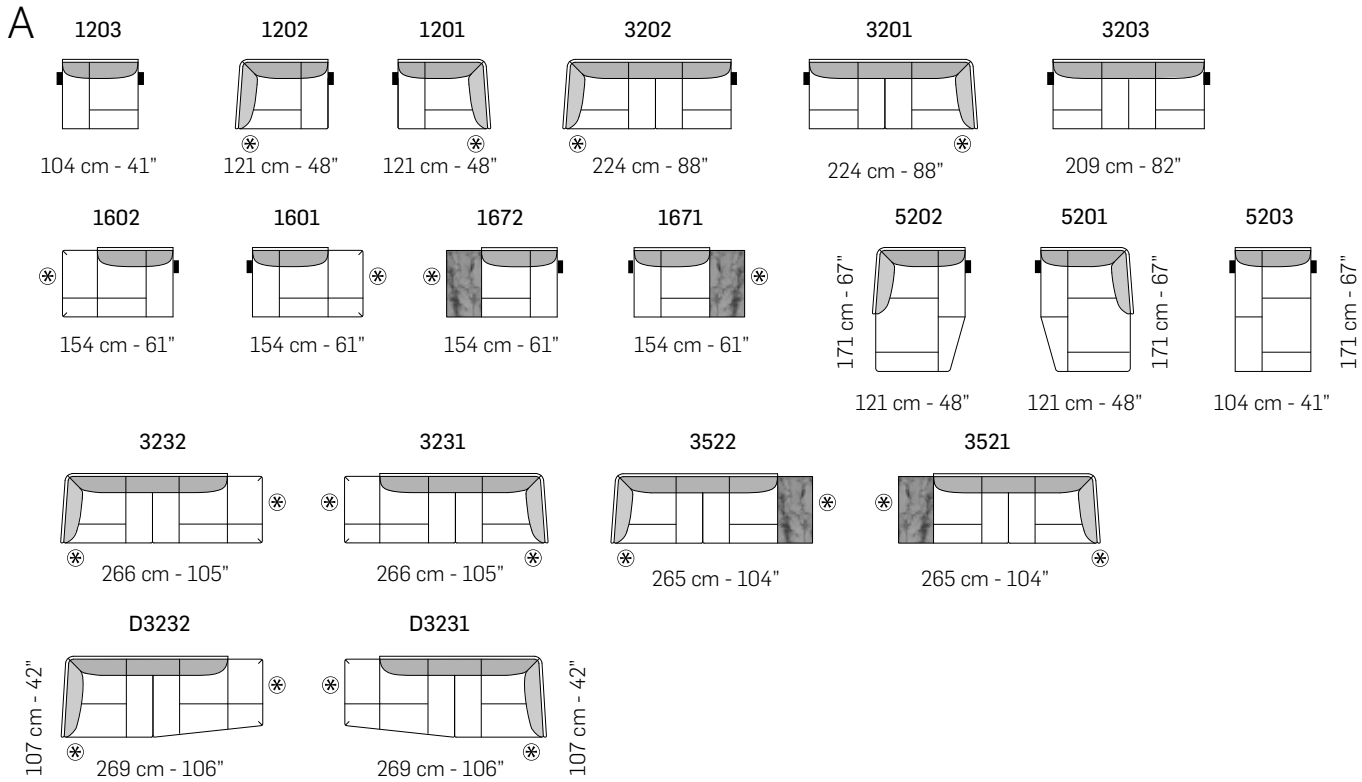
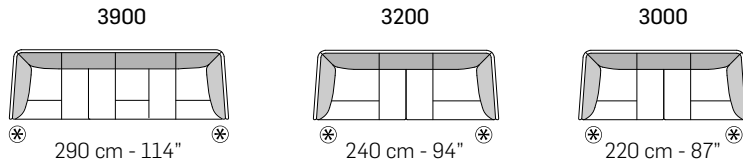

tutti gli elementi del gruppo A hanno lo stesso modulo di seduta - all items in group A have the same seat width

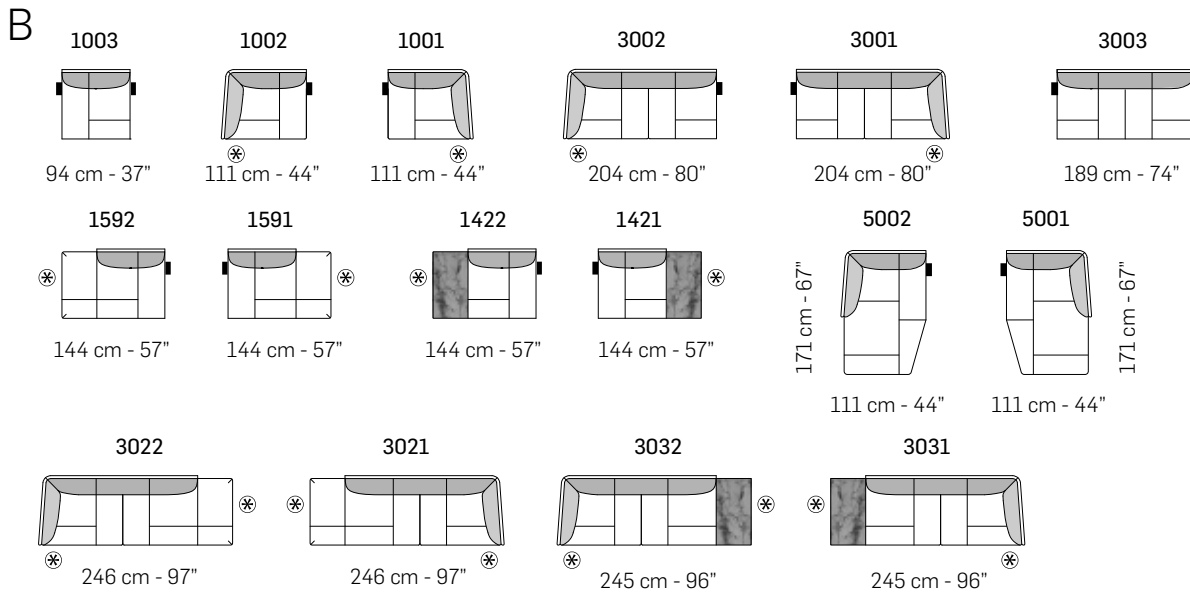

tutti gli elementi del gruppo B hanno lo stesso modulo di seduta - all items in group B have the same seat width

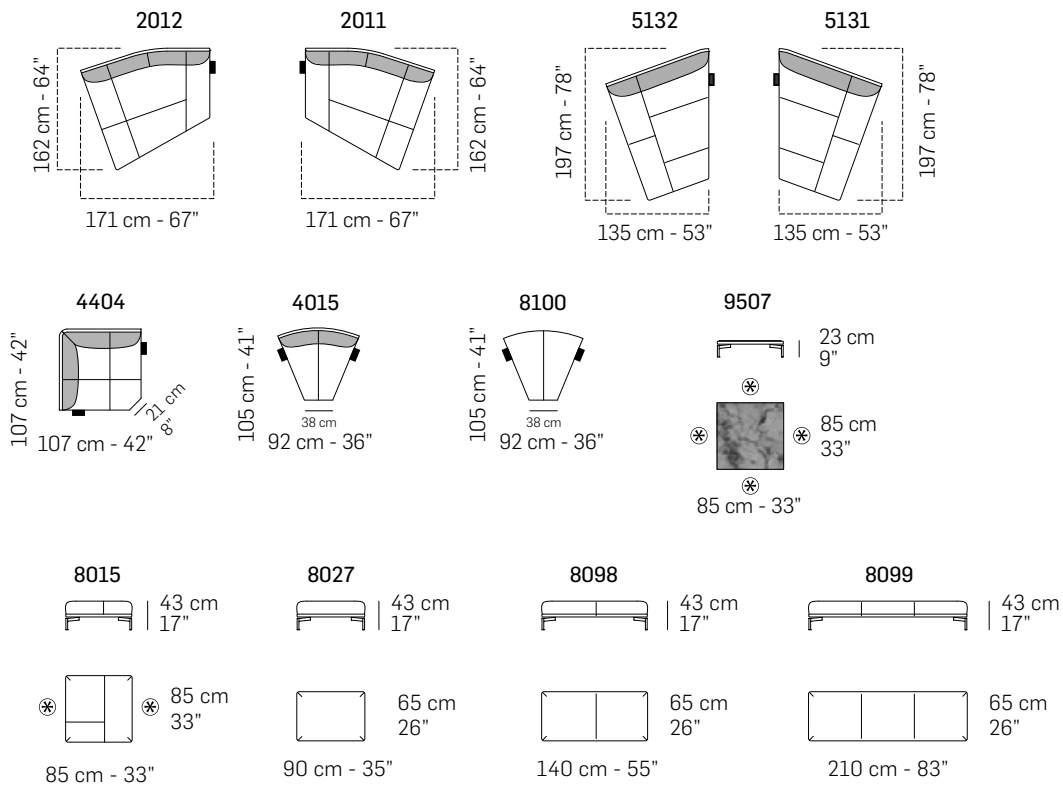

CUSCINETTI CONSIGLIATI / SUGGESTED PILLOWS

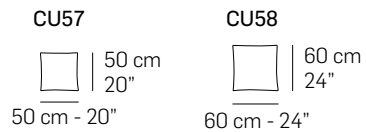

COMPOSIZIONI CONSIGLIATE / SUGGESTED COMPOSITIONS

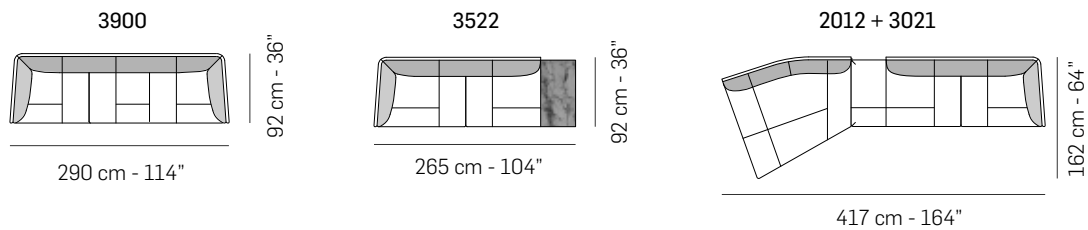

Scala 1:100  
Ratio 1 to 100

Legenda / Legend

- Spalliera / Back Cushions
- Bracciolo / Armrest
- Marmo / Marble
- Poggiareni / Kidneyrest
- Seduta / Seat Cushions
- ⊗ Lato terminale sempre rifinito e agganciabile agli elementi componibili / Terminal side is always finished and it can also be connected to modular elements
- Aggancio Componibile / Connector

Note / Notes

Nicoline si riserva il diritto di apportare in ogni momento modifiche tecniche ed estetiche / Nicoline reserves the right to change, at any time and without prior warning, technical and aesthetic specifications of the articles.



# NAUSICAA

Design Application N° 402016000053464



frontale // front



laterale // depth

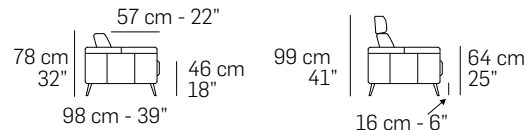

## Caratteristiche standard

- Struttura in legno e multistrato, molleggio seduta e spalliera con cinghie elastiche.
- Imbottitura in poliuretano espanso ecologico a cellula aperta con densità differenziate.
- Rivestimento in pelle o tessuto con cuscini di seduta e spalliera sfoderabili.
- Solo per il mercato ITALIA il rivestimento in tessuto è completamente sfoderabile.
- Piede in metallo Lucido (Cod.30), Satinato (Cod.31), Canna di fucile (Cod.50), Bronzo anticato (Cod.52).
- Elementi Cod.1501- 1502 - 1671 - 1672 - 2341 - 2342 - 3031 - 3032 - 8091 con ripiano in marmo Emperador (Cod.EM) oppure con marmo Bianco Carrara (Cod.CA).
- Cucitura Cod.06 per rivestimento in pelle.
- Inserimento letto non possibile.
- Lato componibile rifinito.

## Caratteristiche optional su richiesta senza maggiorazione

- Disponibile con cucitura a contrasto, per la scelta del colore fare riferimento ai codici del campionario pelli.

## Caratteristiche optional su richiesta con maggiorazione

- Poggiatesta (Cod.9900) con imbottitura in poliuretano espanso ecologico a cellula aperta e rivestimento sfoderabile.
- Per il multi rivestimento il prezzo va incrementato del 3%. Per maggiori dettagli fare riferimento al paragrafo "NOTE" posto nelle prime pagine del listino.

## Note

- I disegni grafici che riportano l'asterisco (\*) sono sempre con lato rifinito e anche agganciabili agli elementi componibili.
- Non è possibile applicare altre cuciture.

## Standard features

- Frame: wooden structure, seat and back suspensions in reinforced elastic webbing.
- Seat cushions with padding in eco-friendly open cell polyurethane foam, with different densities.
- Covering in leather or fabric. Seat and back cushions coverings removable.
- Legs in Shiny metal (Cod.30), Satin (Cod.31), Gunmetal (Cod.50), Antique bronze (Cod.52).
- Versions Cod.1501 - 1502 - 1671 - 1672 - 2341 - 2342 - 3031 - 3032 - 8091 with top in marble Emperador (Cod.EM) or Carrara white marble (Cod.CA).
- Stitching type Cod.06 for leather covering.
- No bed version available.
- Sectional sides finished.

## Optional features without any upcharge

- Contrast stitching available. Please refer to our leather collection for a thread color indication.

## Optional features with upcharge

- Headrest (Cod.9900) with padding in open cell polyurethane foam and removable covering.
- 3% upcharge for combined coverings. Please refer to the notes at the beginning of pricelist.

## Notes

- Versions with asterisk (\*) have always the finished terminal side with the possibility to be connected to modular elements.
- Different stitchings not available.



Piede in metallo // Metal legs

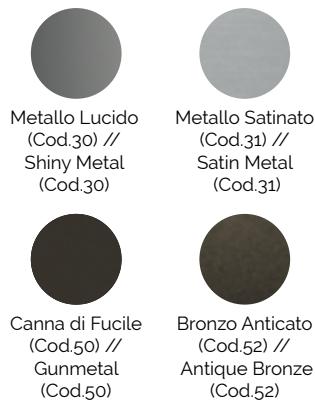

Cuciture // Stitching

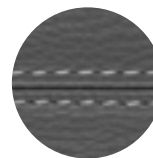

Cod.06



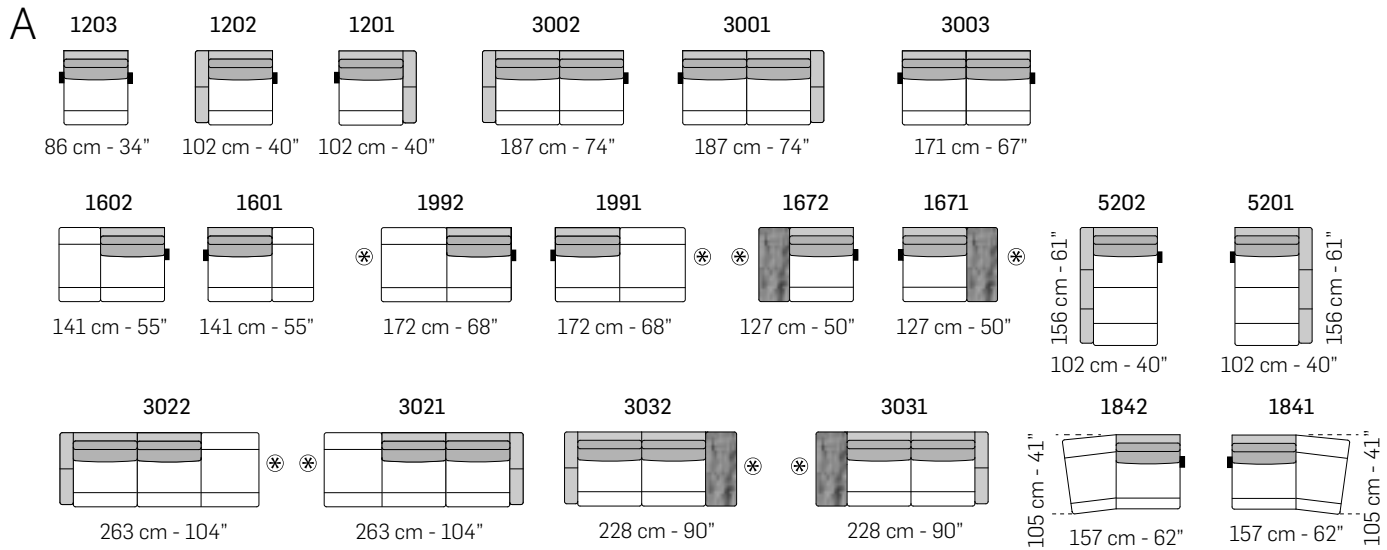
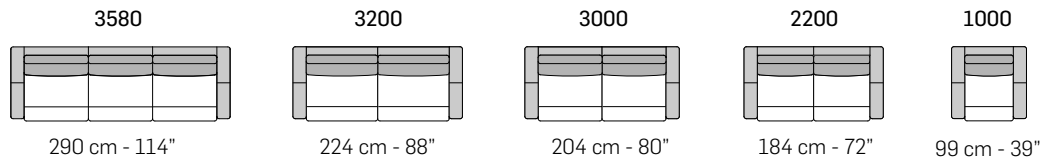

tutti gli elementi del gruppo A hanno lo stesso modulo di seduta - all items in group A have the same seat width

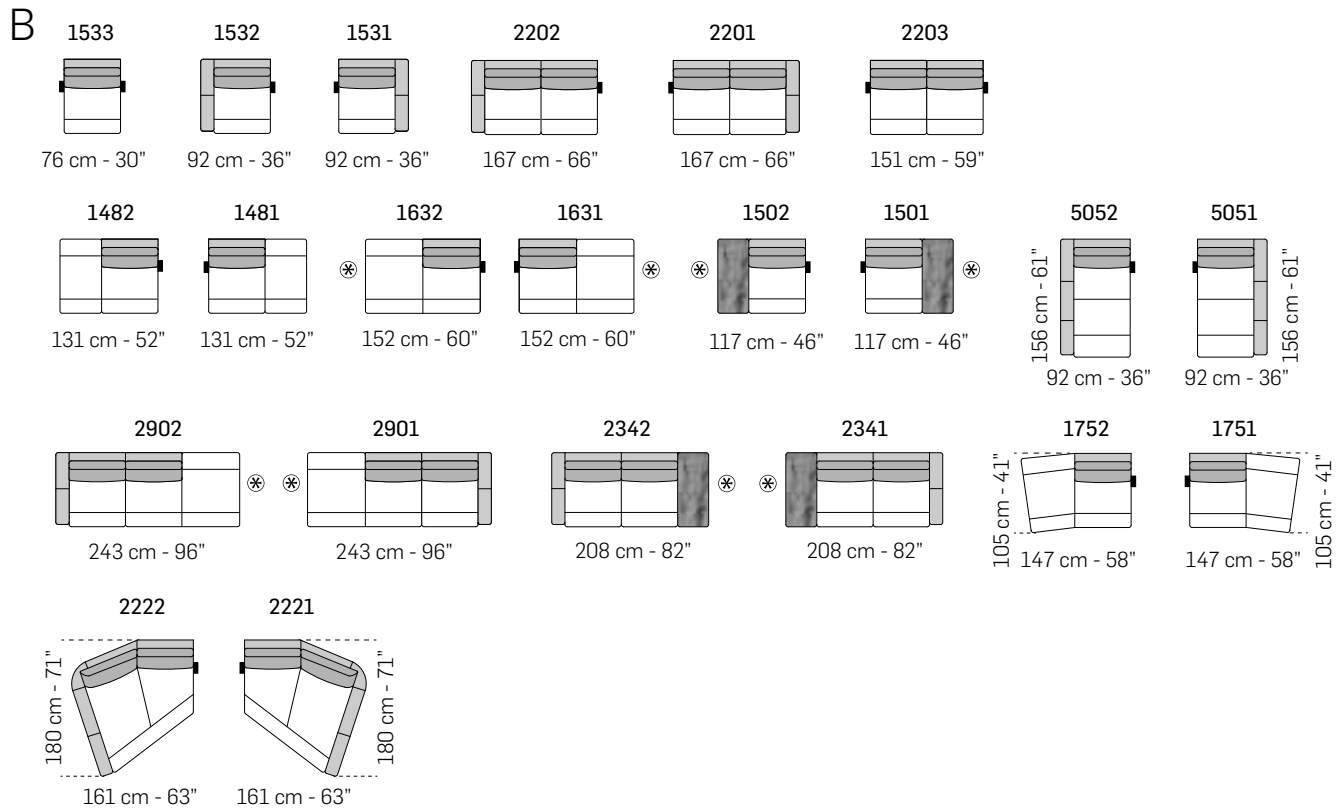

tutti gli elementi del gruppo B hanno lo stesso modulo di seduta - all items in group B have the same seat width

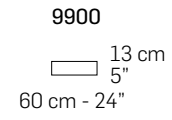
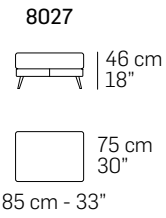
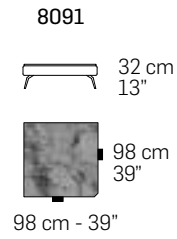
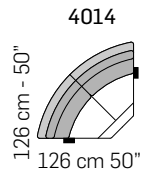
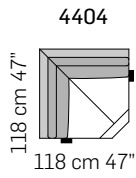

COMPOSIZIONI CONSIGLIATE / SUGGESTED COMPOSITIONS

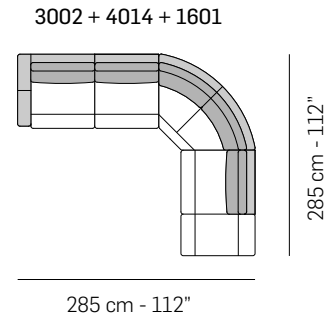
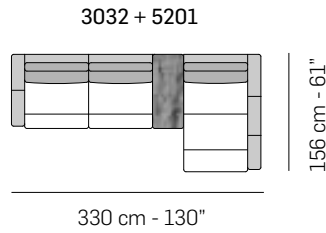
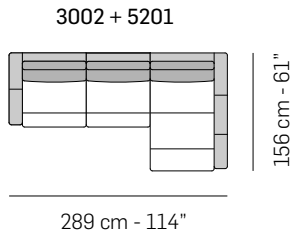

Scala 1:100  
Ratio 1 to 100

Legenda / Legend

- Spalliera / Back Cushions
- Bracciolo / Armrest
- Marmo / Marble
- Poggiareni / Kidneyrest
- Seduta / Seat Cushions
- ⊗ Lato terminale sempre rifinito e agganciabile agli elementi componibili / Terminal side is always finished and it can also be connected to modular elements
- Aggancio Componibile / Connector

Note / Notes

Nicoline si riserva il diritto di apportare in ogni momento modifiche tecniche ed estetiche / Nicoline reserves the right to change, at any time and without prior warning, technical and aesthetic specifications of the articles.



# PACIFIC SQUARE

Design Application N° 008642821-0018

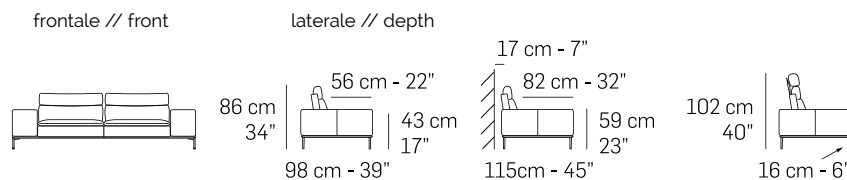

## Caratteristiche standard

- Struttura in legno e multistrato, molleggio seduta con cinghie elastiche.
- Imbottiture in poliuretano espanso ecologico a cellula aperta con densità differenziate.
- Rivestimento in pelle o tessuto. Tutti i rivestimenti sono fissi.
- Piede in metallo Canna di fucile (Cod.50), Bronzo anticato (Cod.52).
- I cuscini di schienale sono dotati di meccanismo "pendular".
- Cucitura Cod.01 per rivestimento in pelle.
- Cucitura Cod.03 per rivestimento in tessuto.
- Inserimento letto non possibile.
- Lato componibile rifinito.

Caratteristiche optional su richiesta senza maggiorazione

- Disponibile con cucitura a contrasto, per la scelta del colore fare riferimento ai codici del campionario pelli.

## Caratteristiche optional su richiesta con maggiorazione

- Poggiatesta (Cod.9900 - 9902) con imbottitura in poliuretano espanso ecologico a cellula aperta e rivestimento sfoderabile.
- Per il multi rivestimento il prezzo va incrementato del 7%. Per maggiori dettagli fare riferimento al paragrafo "NOTE" posto nelle prime pagine del listino.

## Note

- I disegni grafici che riportano l'asterisco (\*) sono sempre con lato rifinito e anche agganciabili agli elementi componibili.
- Non è possibile applicare altre cuciture.
- Per alcuni tessuti e velluti l'azienda si riserva di applicare la cucitura Cod.00 / Cod.03 (vedi immagine).

## Standard features

- Frame: wooden structure, seat suspensions in reinforced elastic webbing.
- Paddings in eco-friendly open cell polyurethane foam, with different densities.
- Covering in leather or fabric. Not removable coverings.
- Legs in Gunmetal (Cod.50), Antique bronze (Cod.52).
- Back cushion with pendular mechanism on all elements.
- Stitching type Cod.01 for leather coverings.
- Stitching type Cod.03 for fabric coverings.
- No bed version available.
- Sectional sides finished.

## Optional features available upon request with no upcharge

- Stitching, unless differently requested, will be matching the leather or fabric colour. Contrast stitching colour can be ordered at no extra charge. You might use as reference any Nicoline leather.

## Optional features available upon request with an upcharge

- Headrest (Cod.9900 - 9902) in eco-friendly open cell polyurethane foam and removable covering.
- 7% upcharge for combined coverings. Please refer to the notes at the beginning of pricelist.

## Notes

- Versions with asterisk (\*) have always the terminal side finished with the possibility to be connected to modular elements.
- Different stitchings not available.
- For some fabrics and velvets production dept. must apply the stitching Cod.00 / Cod.03 (as per picture below).



Piede in metallo // Metal legs



Canna di Fucile (Cod.50) // Gunmetal (Cod.50)



Bronzo Anticato (Cod.52) // Antique Bronze (Cod.52)



I cuscini di schienale sono dotati di meccanismo "pendular" // Back cushion with pendular mechanism on all elements



Poggiatesta // Headrest

Cuciture // Stitching



Cod.00

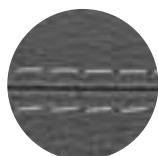

Cod.01

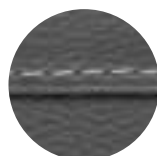

Cod.03



Braccioli fissi // Fixed armrests

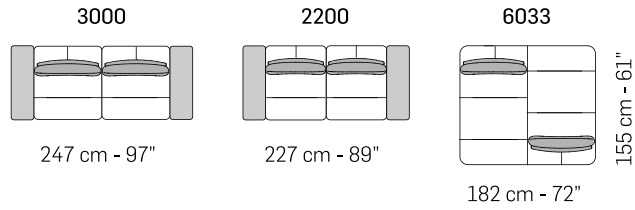

A

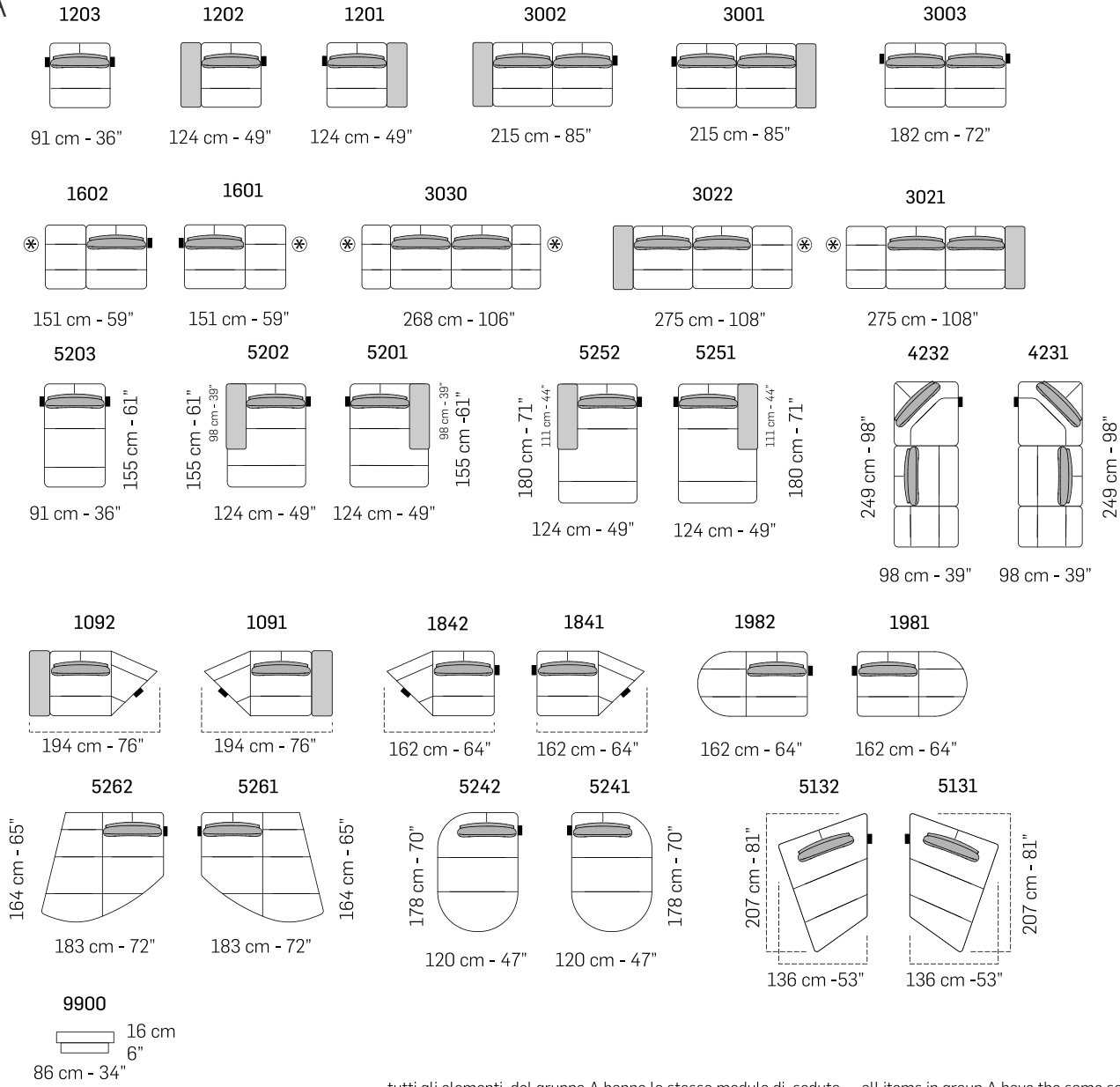

tutti gli elementi del gruppo A hanno lo stesso modulo di seduta - all items in group A have the same seat width

B

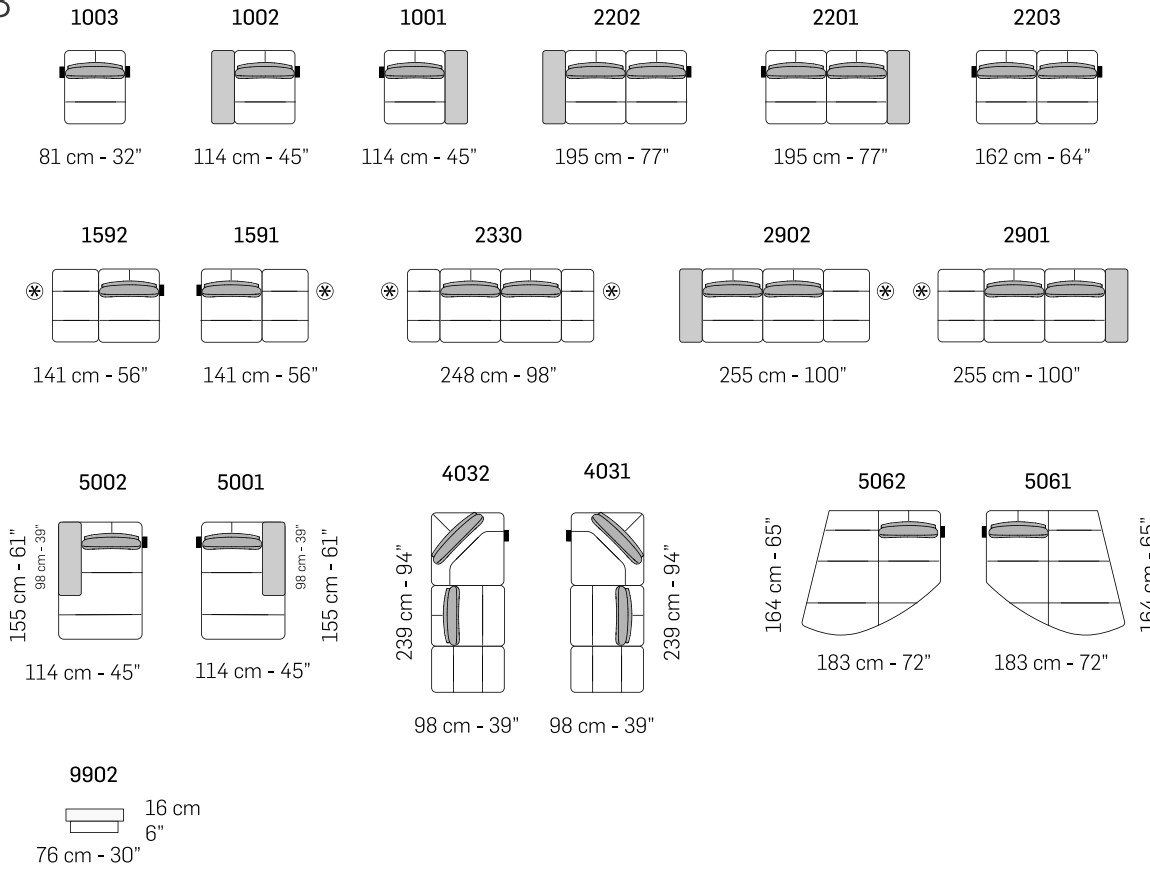

tutti gli elementi del gruppo B hanno lo stesso modulo di seduta - all items in group B have the same seat width

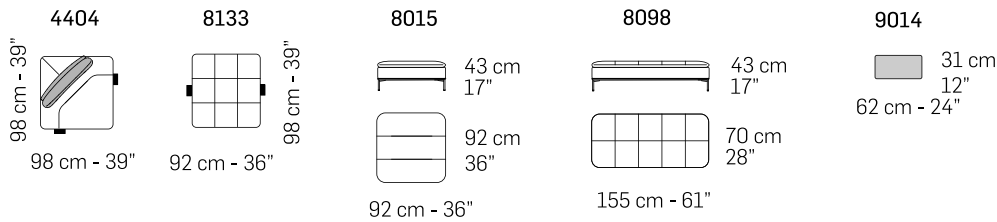

COMPOSIZIONI CONSIGLIATE / SUGGESTED COMPOSITIONS

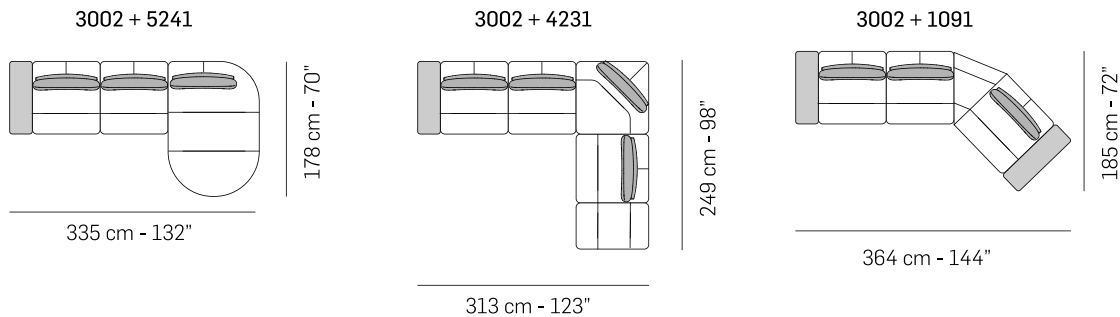

Scala 1:100  
Ratio 1 to 100

Legenda / Legend

■ Spalliera / Back Cushions ■ Bracciolo / Armrest  
■ Poggiareni / Kidneyrest □ Seduta / Seat Cushions

⊗ Lato terminale sempre rifinito e agganciabile agli elementi componibili / Terminal side is always finished and it can also be connected to modular elements

■ Aggancio Componibile / Connector

Note / Notes

Nicoline si riserva il diritto di apportare in ogni momento modifiche tecniche ed estetiche / Nicoline reserves the right to change, at any time and without prior warning, technical and aesthetic specifications of the articles.



# PENTA

Design Application N° 008642821-0015

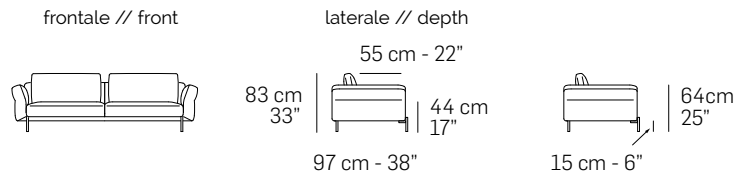

## Caratteristiche standard

- Struttura in multistrato, massello di abete e base in MDF con rinforzi in metallo, molleggio seduta e spalliera con cinghie elastiche.
- Imbottiture in poliuretano espanso ecologico a cellula aperta con densità differenziate.
- Cuscini di schienale in fibra "Extra soft".
- Rivestimento in pelle o tessuto con cuscini di seduta e spalliera sfoderabili.
- Elementi Cod.1421 - 1422 - 1671 - 1672 - 3031 - 3032 - 3521 - 3522 con ripiano in marmo Bianco Carrara (Cod.CA).
- Piede (PM001) in metallo Canna di fucile (Cod.50), Ottone satinato (Cod.51), Bronzo anticato (Cod.52).
- Cucitura Cod.01 + Cod.03 per rivestimento in pelle.
- Cucitura Cod.03 per rivestimento in tessuto.
- Inserimento letto non possibile.
- Lato componibile rifinito.

## Caratteristiche optional su richiesta senza maggiorazione

- Piede (PM002) in metallo Canna di fucile (Cod.50), Ottone satinato (Cod.51), Bronzo anticato (Cod.52).
- Disponibile con cucitura a contrasto, per la scelta del colore fare riferimento ai codici del campionario pelli.

## Caratteristiche optional su richiesta con maggiorazione

- Per il multi rivestimento il prezzo va incrementato del 7%. Per maggiori dettagli fare riferimento al paragrafo "NOTE" posto nelle prime pagine del listino.
- Elementi Cod. 1421 - 1422 - 1671 - 1672 - 3031 - 3032 - 3521 - 3522 con ripiano in marmo Emperador (Cod.EM), Nero Marquinia (Cod.NM).

## Note

- I disegni grafici che riportano l'asterisco (\*) sono sempre con lato rifinito e anche agganciabili agli elementi componibili.
- Non è possibile applicare altre cuciture.
- Per alcuni tessuti e velluti l'azienda si riserva di applicare la cucitura Cod.00 / Cod.03 (vedi immagine).

## Standard features

- Frame: wooden structure, solid fir wood with MDF base with metal reinforcements, seat suspensions in reinforced elastic webbing.
- Paddings in eco-friendly open cell polyurethane foam, with different densities.
- Back cushions in "Extra soft" fiber.
- Covering in leather or fabric. Seat and back cushions coverings removable.
- Versions Cod.1421 - 1422 - 1671 - 1672 - 3031 - 3032 - 3521 - 3522 with top in White Carrara marble (Cod.CA).
- Legs (PM001) in Gunmetal (Cod.50), Satin Brass (Cod.51), Antique bronze (Cod.52).
- Stitching type Cod.01 + Cod.03 for leather covering.
- Stitching type Cod.03 for fabric covering.
- No bed version available.
- Sectional sides finished.

## Optional features available upon request without any upcharge

- Legs (PM002) in Gunmetal (Cod.50), Satin Brass (Cod.51), Antique bronze (Cod.52).
- Stitching, unless differently requested, will be matching the leather or fabric colour. Contrast stitching colour can be ordered at no extra charge. You might use as reference any Nicoline leather.

## Optional features available upon request with an upcharge

- 7% upcharge for combined coverings. Please refer to the notes at the beginning of pricelist.
- Versions Cod. 1421 - 1422 - 1671 - 1672 - 3031 - 3032 - 3521 - 3522 with top in Emperador marble (Cod.EM), Black Marquinia marble (Cod.NM).

## Notes

- Versions with asterisk (\*) have always the terminal side finished with the possibility to be connected to modular elements.
- Different stitchings not available.
- For some fabrics and velvets production dept. must apply the stitching Cod.00 / Cod.03 (as per picture below).



Piede in metallo standard (PM001) // Metal leg standard (PM001)

Piede in metallo opzionale (PM002) // Metal leg optional (PM002)

 Canna di Fucile (Cod.50) // Gunmetal (Cod.50)

 Ottone Satinato (Cod.51) // Satin Brass (Cod.51)

 Bronzo Anticato (Cod.52) // Antique Bronze (Cod.52)

Cuciture // Stitching



Cod.00

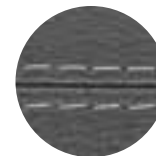

Cod.01

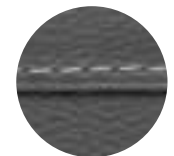

Cod.03



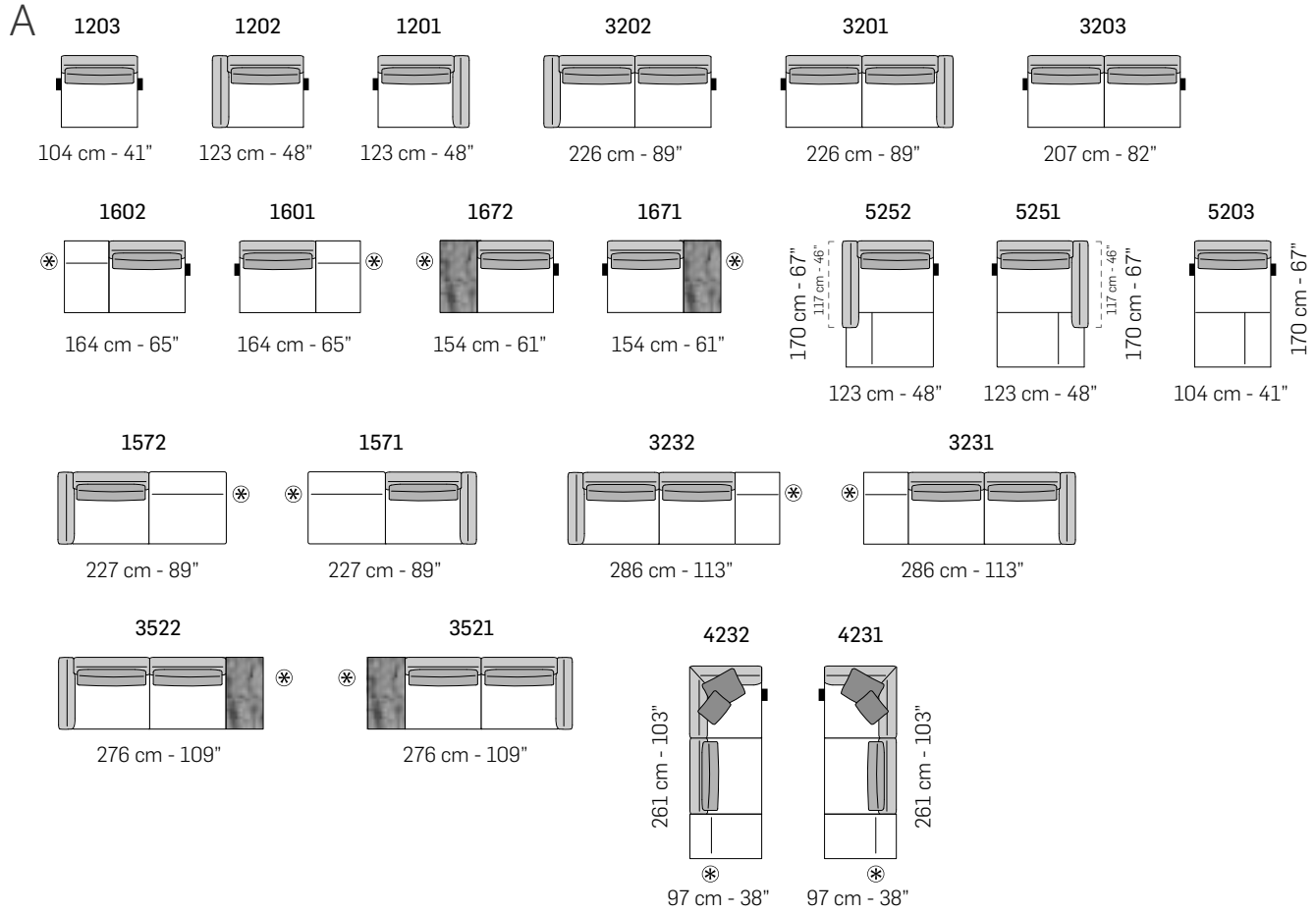
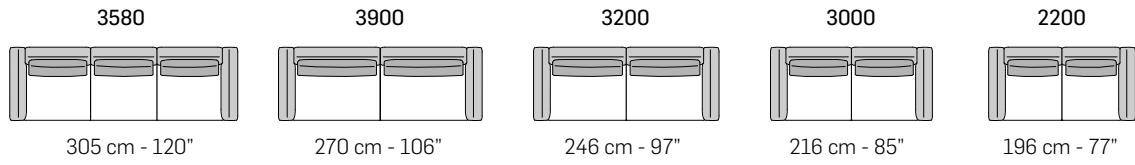

tutti gli elementi del gruppo A hanno lo stesso modulo di seduta - all items in group A have the same seat width

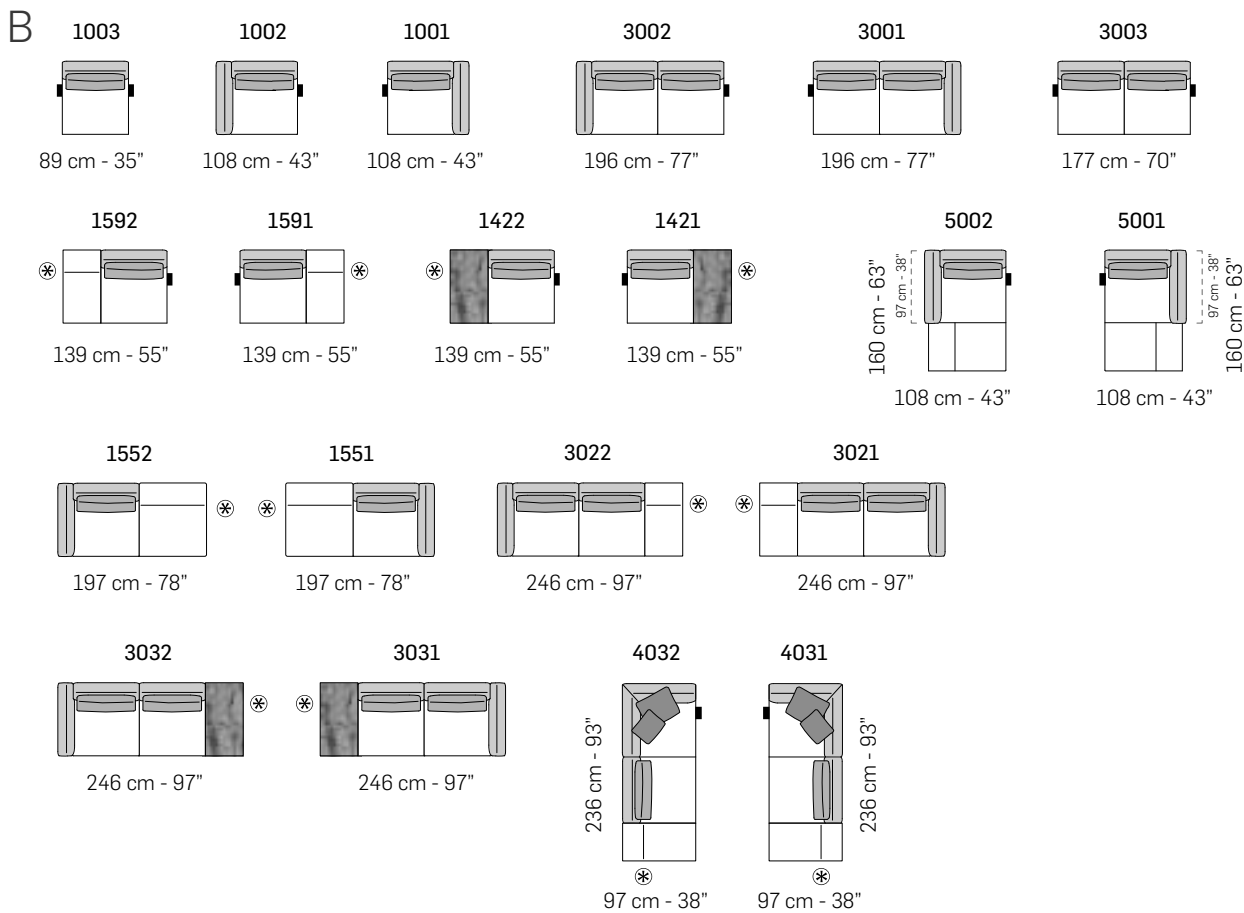

tutti gli elementi del gruppo B hanno lo stesso modulo di seduta - all items in group B have the same seat width

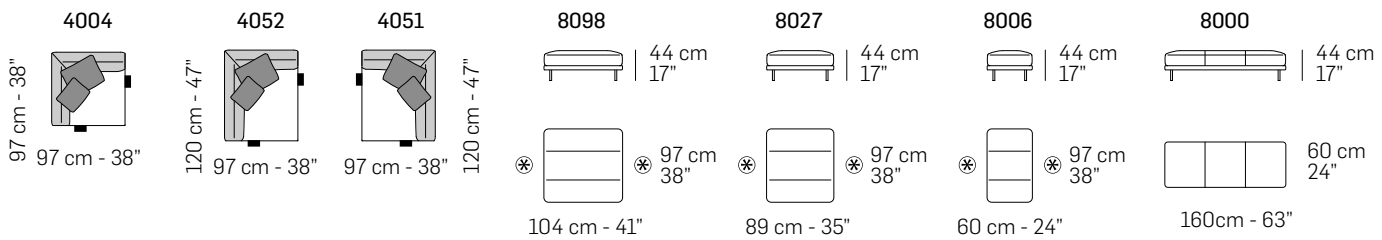

CUSCINETTI CONSIGLIATI / SUGGESTED PILLOWS

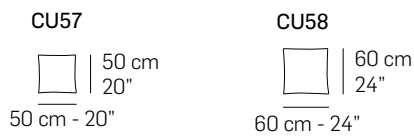

COMPOSIZIONI CONSIGLIATE / SUGGESTED COMPOSITIONS

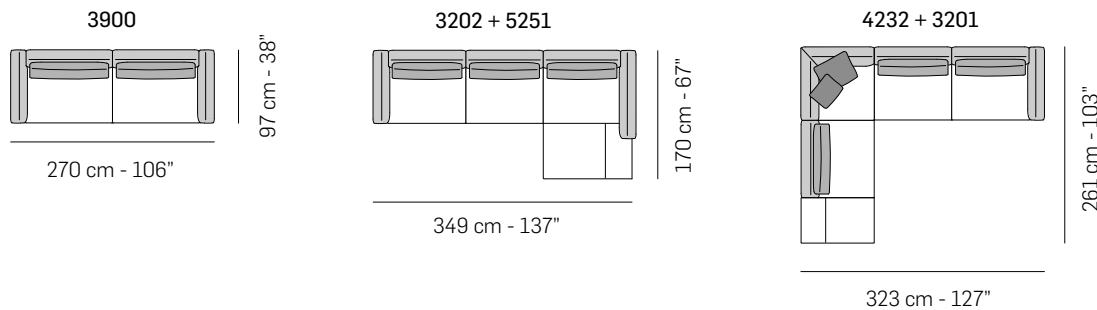

Scala 1:100  
Ratio 1 to 100

Legenda / Legend

- Spalliera / Back Cushions
- Bracciolo / Armrest
- Marmo / Marble
- Poggiareni / Kidneyrest
- Seduta / Seat Cushions
- ⊗ Lato terminale sempre rifinito e agganciabile agli elementi componibili / Terminal side is always finished and it can also be connected to modular elements
- Aggancio Componibile / Connector

Note / Notes

Nicoline si riserva il diritto di apportare in ogni momento modifiche tecniche ed estetiche / Nicoline reserves the right to change, at any time and without prior warning, technical and aesthetic specifications of the articles.



# PLAY

Design Application N° 008642821-0016

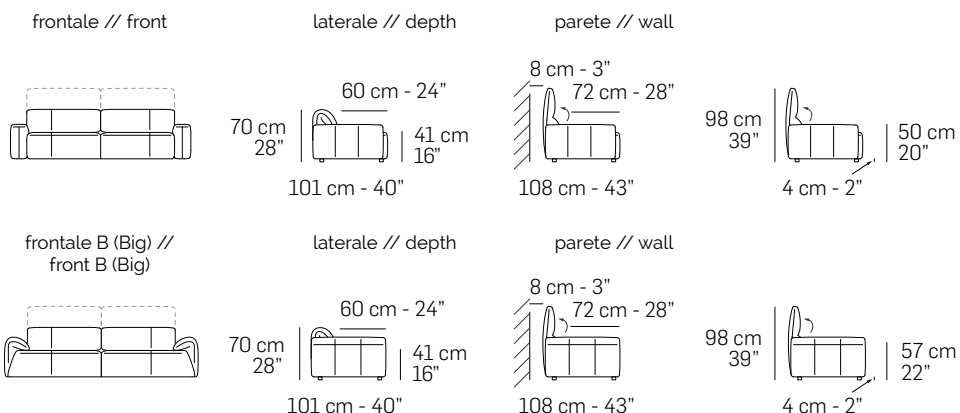

## Caratteristiche standard

- Struttura in multistrato e massello di abete con rinforzi in metallo, molleggio seduta con cinghie elastiche.
- Imbottiture in poliuretano espanso ecologico a cellula aperta con densità differenziate.
- Rivestimento in pelle o tessuto. Tutti i rivestimenti sono fissi.
- Schienali dotati di meccanismo a snodo che si ripiega verso l'interno.
- Piedi in materiale termoplastico nero.
- Le cuciture per il rivestimento in pelle sono realizzate nel seguente modo:  
Cucitura Cod.01 su cuscino di seduta, scocca braccio e parte centrale spalliera.  
Cucitura Cod.03 per parte perimetrale spalliera.
- Il rivestimento in tessuto non possiede cuciture.
- Inserimento letto non possibile.
- Lato componibile rifinito.

## Caratteristiche optional su richiesta senza maggiorazione

- Disponibile con cucitura a contrasto, per la scelta del colore fare riferimento ai codici del campionario pelli.

## Caratteristiche optional su richiesta con maggiorazione

- Per il multi rivestimento il prezzo va incrementato del 7%, ad eccezione di quanto riportato nel paragrafo "senza maggiorazione". Per maggiori dettagli fare riferimento al paragrafo "NOTE" posto nelle prime pagine del listino.

## Note

- I disegni grafici che riportano l'asterisco (\*) sono sempre con lato rifinito e anche agganciabili agli elementi componibili.
- Non è possibile applicare altre cuciture.

## Standard features

- Frame: wooden structure and solid fir wood with metal reinforcements, seat suspensions in reinforced elastic webbing.
- Paddings in eco-friendly open cell polyurethane foam, with different densities.
- Covering in leather or fabric. Not removable coverings.
- Backrests equipped with junction mechanism that folds inwards.
- Legs in black thermoplastic material.
- Stitchings only for the leather covering are being placed as per the following:  
Stitching type Cod.01 for seat cushion, armrest frame and central part of backrest;  
Stitching type Cod.03 for backrest perimetral part.
- No stitchings for fabric covering.
- No bed version available.
- Sectional sides finished.

## Optional features available upon request without any upcharge

- Stitching, unless differently requested, will be matching the leather or fabric color. Contrast stitching color can be ordered at no extra charge. You might use as reference any Nicoline leather.

## Optional features available upon request with an upcharge

- 7% upcharge for combined coverings, except as indicated in the paragraph "without any upcharge". Please refer to the notes at the beginning of pricelist.

## Notes

- Versions with asterisk (\*) have always the terminal side finished with the possibility to be connected to modular elements.
- Different stitchings not available.



Cuciture //  
Stitching

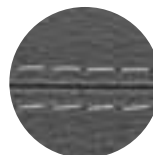

Cod.01

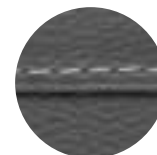

Cod.03

I cuscini di schienale sono dotati di meccanismo //  
Back cushion with mechanism on all elements

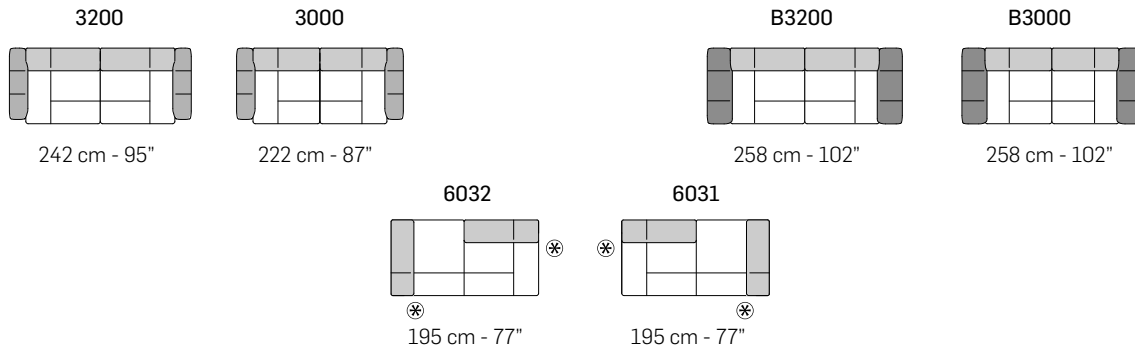

A

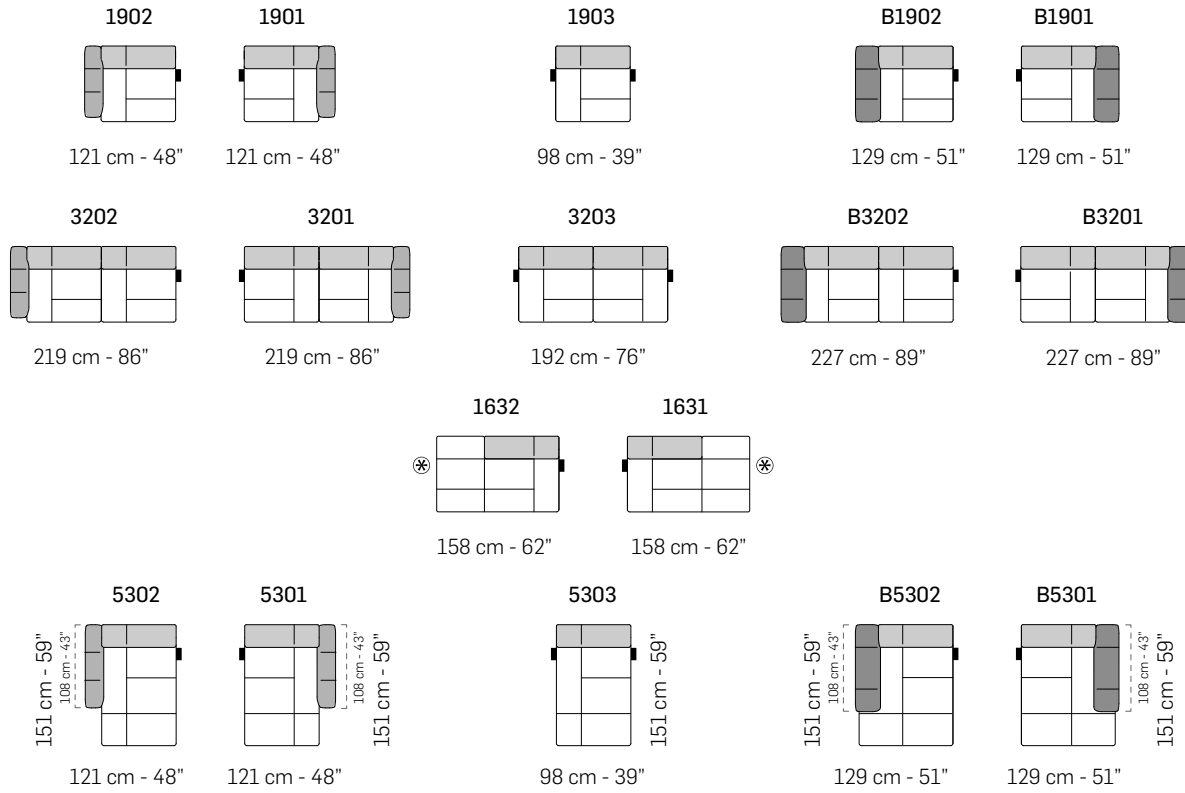

tutti gli elementi del gruppo A hanno lo stesso modulo di seduta - all items in group A have the same seat width

B

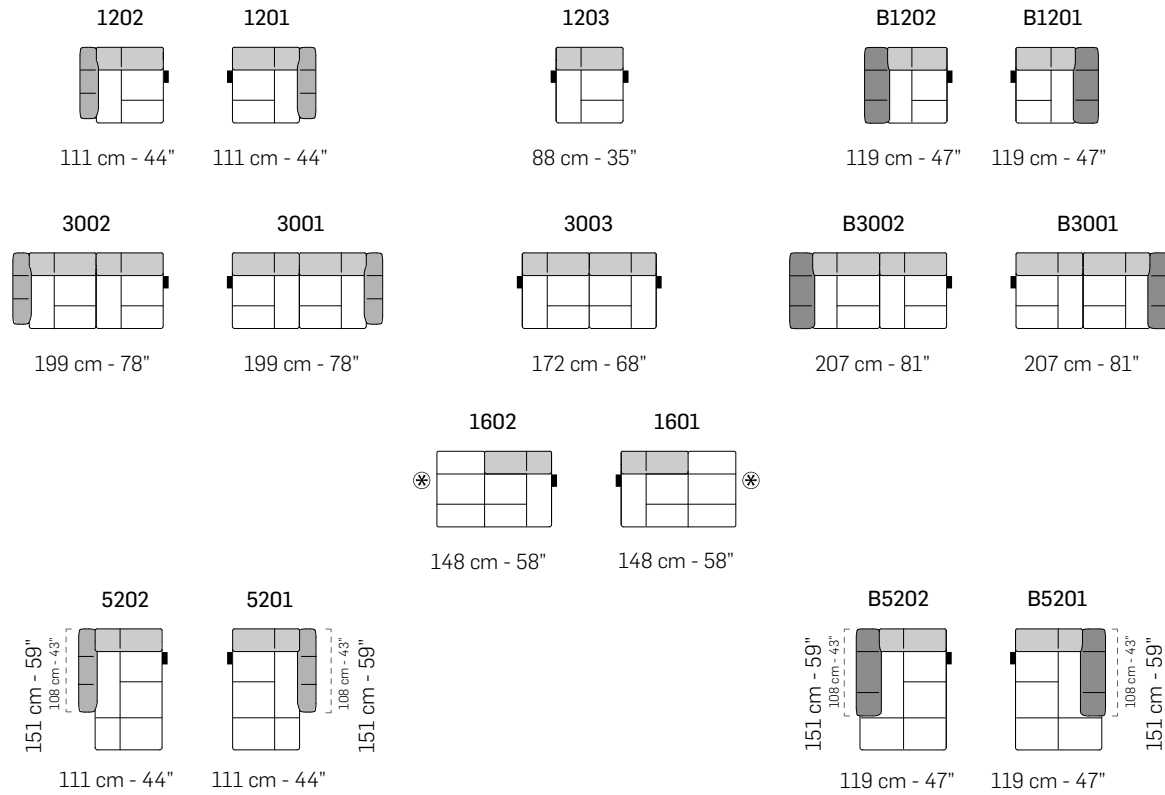

tutti gli elementi del gruppo B hanno lo stesso modulo di seduta - all items in group B have the same seat width

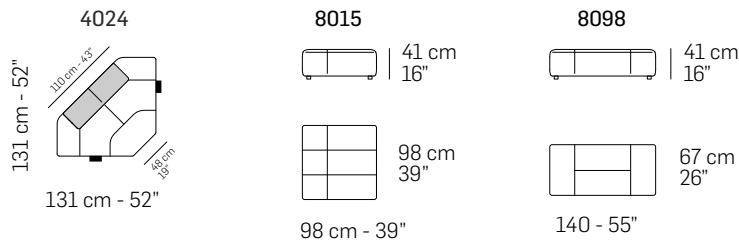

CUSCINETTI CONSIGLIATI / SUGGESTED PILLOWS

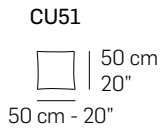

COMPOSIZIONI CONSIGLIATE / SUGGESTED COMPOSITIONS

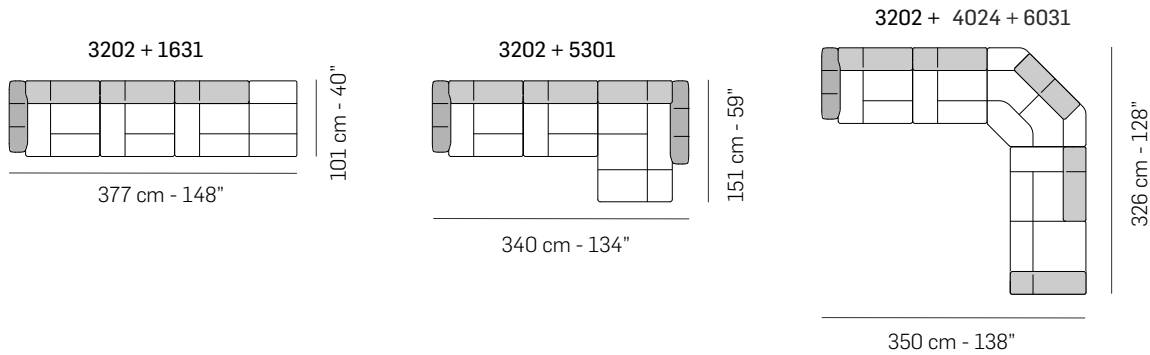

Scala 1:100  
Ratio 1 to 100

Legenda / Legend

- Spalliera / Back Cushions
- Bracciolo / Armrest
- Bracciolo B / Armrest B
- Poggiareni / Kidneyrest
- Seduta / Seat Cushions
- Aggancio Componibile / Connector

⊗ Lato terminale sempre rifinito e agganciabile agli elementi componibili / Terminal side is always finished and it can also be connected to modular elements

Note / Notes

Nicoline si riserva il diritto di apportare in ogni momento modifiche tecniche ed estetiche / Nicoline reserves the right to change, at any time and without prior warning, technical and aesthetic specifications of the articles.



# STRAUSS

Design Application N° 008642821-0019

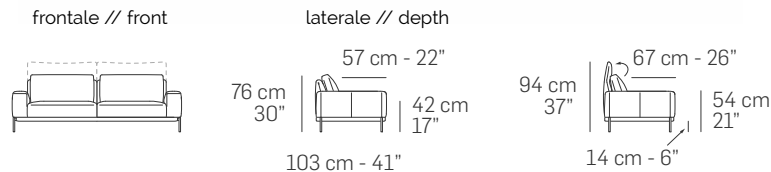

## Caratteristiche standard

- Struttura in multistrato, massello di abete e base in MDF con rinforzi in metallo, molleggio seduta con cinghie elastiche.
- Imbottiture in poliuretano espanso ecologico a cellula aperta con densità differenziate. I cuscini di spalliera sono in piuma d'oca.
- Rivestimento in pelle o tessuto, con cuscini di spalliera sfoderabili.
- Schienali dotati di meccanismo a snodo che si ripiega verso l'interno.
- Piede in metallo Canna di fucile (Cod.50), Ottone satinato (Cod.51), Bronzo anticato (Cod.52).
- Elementi Cod.1421 - 1422 - 1671 - 1672 - 2341 - 2342 - 3031 - 3032 - 9506 - 9507 con ripiano in marmo Bianco Carrara (Cod.CA).
- Cucitura Cod.03 per rivestimento in pelle e tessuto.
- Inserimento letto non possibile.
- Lato componibile rifinito.

## Caratteristiche optional su richiesta senza maggiorazione

- Disponibile con cucitura a contrasto, per la scelta del colore fare riferimento ai codici del campionario pelli.

## Caratteristiche optional su richiesta con maggiorazione

- Per il multi rivestimento il prezzo va incrementato del 7%. Per maggiori dettagli fare riferimento al paragrafo "NOTE" posto nelle prime pagine del listino.
- Elementi Cod.1421 - 1422 - 1671 - 1672 - 2341 - 2342 - 3031 - 3032 - 9506 - 9507 con ripiano in marmo Emperador (Cod.EM), Nero Marquinia (Cod.NM).

## Note

- I disegni grafici che riportano l'asterisco (\*) sono sempre con lato rifinito e anche agganciabili agli elementi componibili.
- Non è possibile applicare altre cuciture.
- Per alcuni tessuti e velluti l'azienda si riserverà di applicare la cucitura Cod.00 / Cod.03 (vedi immagine).

## Standard features

- Frame: wooden structure, solid fir wood with MDF base with metal reinforcements, seat suspensions in reinforced elastic webbing.
- Paddings in eco-friendly open cell polyurethane foam, with different densities. Back cushions in goose down.
- Covering in leather or fabric. Back cushions coverings removable.
- Backrests equipped with junction mechanism that folds inwards.
- Metal legs in Gunmetal (Cod.50), Satin Brass (Cod.51), Antique bronze (Cod.52).
- Versions Cod.1421- 1422- 1671- 1672- 2341- 2342- 3031- 3032- 9506- 9507 with top in White Carrara marble (Cod.CA).
- Stitching type Cod.03 for leather and fabric coverings.
- No bed version available.
- Sectional sides finished.

## Optional features available upon request without any upcharge

- Stitching, unless differently requested, will be matching the leather or fabric colour. Contrast stitching colour can be ordered at no extra charge. You might use as reference any Nicoline leather.

## Optional features available upon request with an upcharge

- 7% upcharge for combined coverings. Please refer to the notes at the beginning of pricelist.
- Versions Cod.1421 - 1422 - 1671 - 1672 - 2341 - 2342 - 3031 - 3032 - 9506 - 9507 with top in marble Emperador (Cod.EM), Black Marquinia marble (Cod.NM).

## Notes

- Versions with asterisk (\*) have always the finished terminal side with the possibility to be connected to modular elements.
- Different stitchings not available.
- For some fabrics and velvets production dept. must apply the stitching Cod.00 / Cod.03 (as per picture below).



Piede in metallo // Metal legs

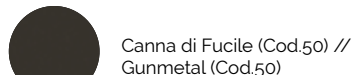

Canna di Fucile (Cod.50) // Gunmetal (Cod.50)

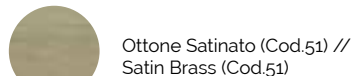

Ottone Satinato (Cod.51) // Satin Brass (Cod.51)



Bronzo Anticato (Cod.52) // Antique Bronze (Cod.52)



Poggiatesta // Headrest



Poggiatesta // Headrest

Cuciture // Stitching



Cod.00

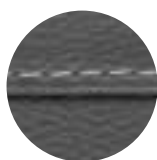

Cod.03



Elementi // Versions



Marmo Bianco Carrara (Cod.CA) // White Carrara marble (Cod.CA)

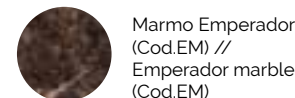

Marmo Emperador (Cod.EM) // Emperador marble (Cod.EM)

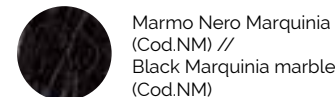

Marmo Nero Marquinia (Cod.NM) // Black Marquinia marble (Cod.NM)



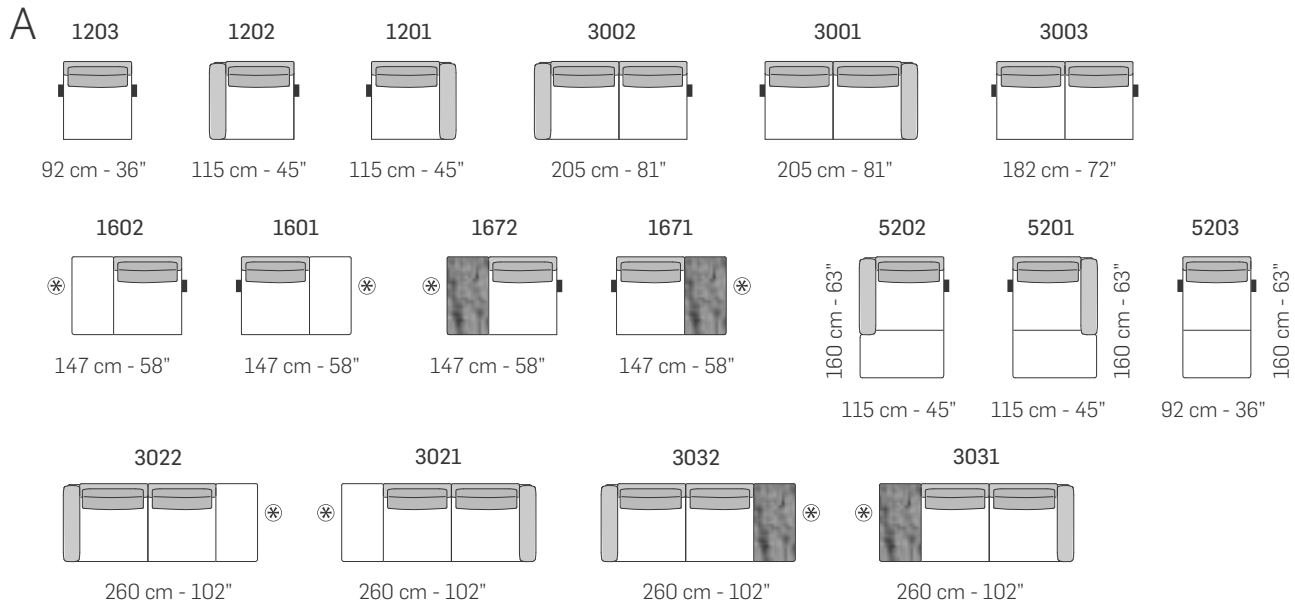
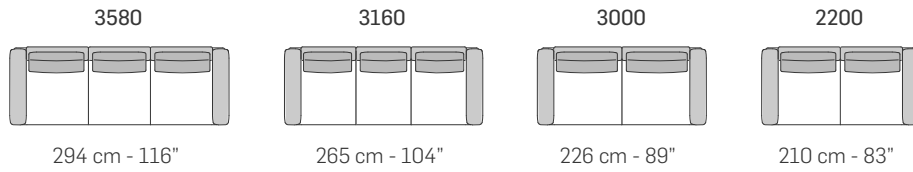

tutti gli elementi del gruppo A hanno lo stesso modulo di seduta - all items in group A have the same seat width

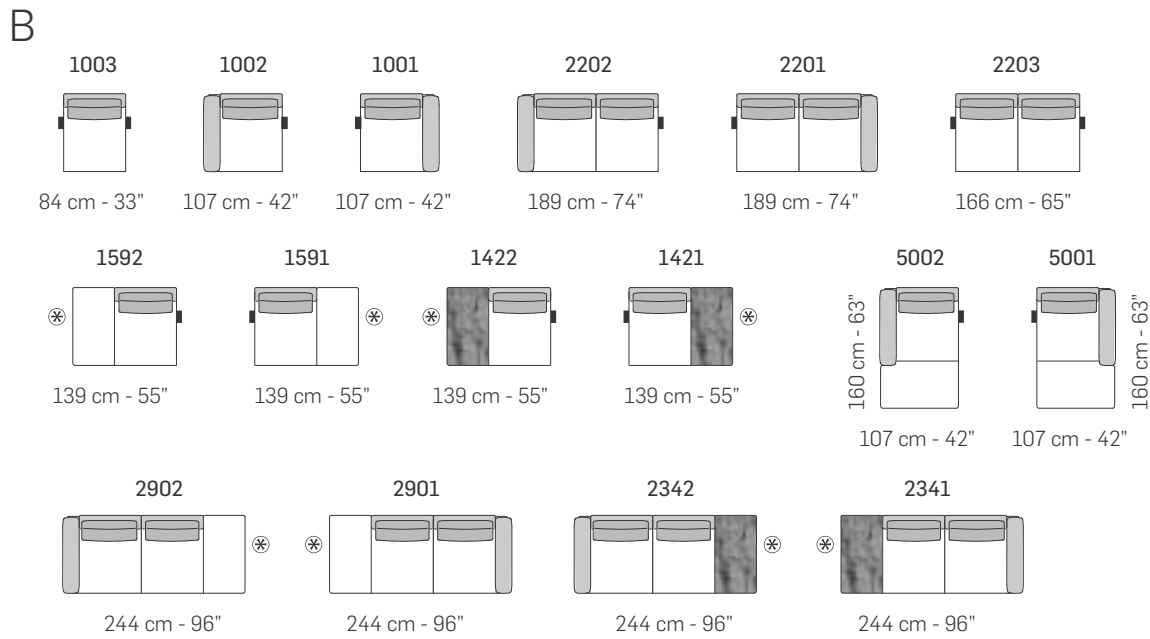

tutti gli elementi del gruppo B hanno lo stesso modulo di seduta - all items in group B have the same seat width

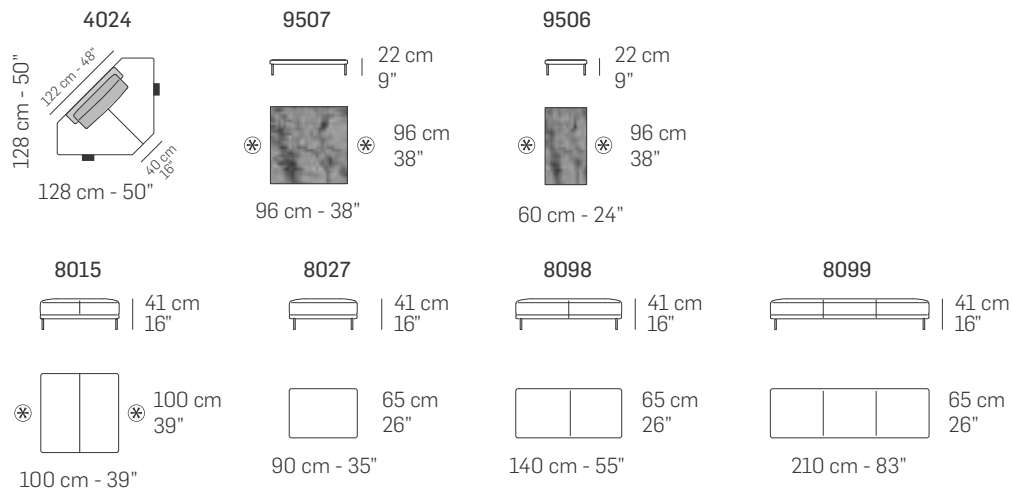

COMPOSIZIONI CONSIGLIATE / SUGGESTED COMPOSITIONS

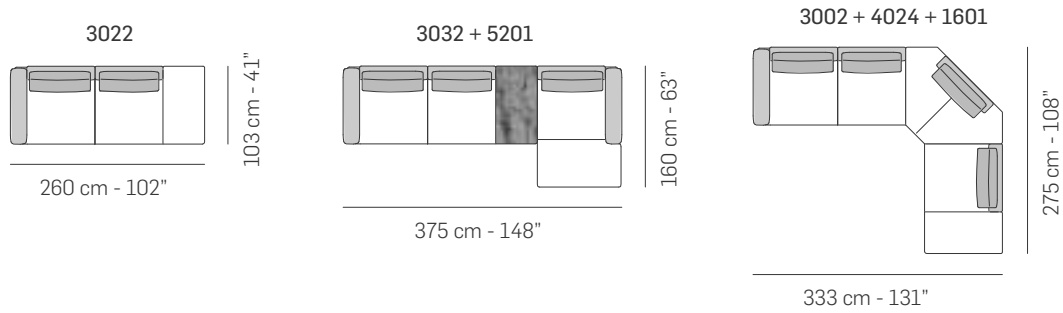

Scala 1:100  
Ratio 1 to 100

Legenda / Legend

■ Spalliera / Back Cushions   ■ Bracciolo / Armrest   ■ Marmo / Marble  
■ Poggiareni / Kidneyrest   □ Seduta / Seat Cushions

⊗ Lato terminale sempre rifinito e agganciabile agli elementi componibili / Terminal side is always finished and it can also be connected to modular elements

■ Aggancio Componibile / Connector

Note / Notes

Nicoline si riserva il diritto di apportare in ogni momento modifiche tecniche ed estetiche / Nicoline reserves the right to change, at any time and without prior warning, technical and aesthetic specifications of the articles.



# ZARA

Design Application N° 402018000002313

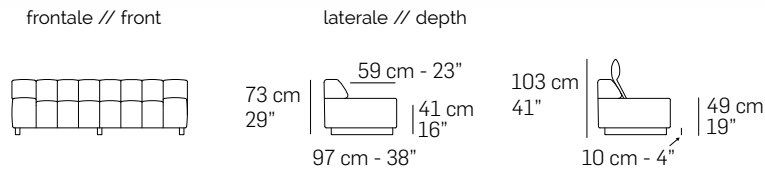

### Caratteristiche standard

- Struttura in legno e multistrato, molleggio seduta e schienale con cinghie elastiche.
- Imbottitura in poliuretano espanso ecologico a cellula aperta con densità differenziate.
- Rivestimento in pelle o tessuto. Tutti i rivestimenti sono fissi.
- Piedi in legno Laccato nero lucido (Cod.27).
- Il tavolino centrale Cod.9504 è disponibile con finitura Noce canaletto (Cod.10).
- Inserimento letto non possibile.
- Lato componibile rifinito.

### Caratteristiche optional su richiesta senza maggiorazione

- Disponibile con cucitura a contrasto. Per la scelta del colore fare riferimento ai codici del campionario pelli.

### Caratteristiche optional su richiesta con maggiorazione

- Poggiatesta (Cod.9900) con imbottitura in poliuretano espanso e supporto in metallo rivestito.
- Tavolino terminale (Cod.9503) con struttura in metallo Canna di fucile (Cod.50) e ripiano in marmo Emperador (Cod.EM) oppure con marmo Bianco Carrara (Cod.CA) fissato alla struttura, per le versioni Cod.1091 - 1092 - 1701 - 1702 - 1841 - 1842 - 2901 - 2902 - 8001 - 8002.

### Note

- Solo per il rivestimento in pelle, sarà realizzato l'inserito in RIO (Fig.1). Per la scelta del colore fare riferimento alla scheda in catalogo e in listino.
- NON è possibile realizzare l'inserito in RIO per il rivestimento in tessuto. In tal caso sarà realizzata cucitura semplice (Fig.2).
- NON è possibile realizzare l'inserito in RIO per il rivestimento in pelle NOBILE e con spessori di pelle superiori a 1.8 mm. In tal caso sarà realizzata cucitura semplice (Fig. 3).
- Per tutte le pelli senza inserto RIO, sarà realizzata una cucitura semplice (Fig. 3)
- Non è possibile realizzare altre tipologie di rivestimento coordinato.

### Standard features

- Frame: wooden structure, seat and back suspensions in reinforced elastic webbing.
- Padding in eco-friendly open cell polyurethane foam, with different densities.
- Covering: in leather or fabric. Not removable coverings.
- Wooden legs in Black gloss lacquer (Cod.27).
- Central table Cod.9504 available with Canaletto walnut (Cod.10) finishing.
- No bed version available.
- Sectional sides finished.

### Optional features without any upcharge

- Contrast stitching available. Please refer to our leather collection for a thread color indication.

### Optional features with upcharge

- Headrest (Cod.9900) with padding in eco-friendly open cell polyurethane foam and covered metal support.
- Terminal table (Cod.9503) with metal structure in Gunmetal (Cod.50) color and top in Emperador marble (Cod.EM) or White Carrara marble (Cod.CA) attached to the structure available for the versions Cod.1091 - 1092 - 1701 - 1702 - 1841 - 1842 - 2901 - 2902 - 8001 - 8002.

### Notes

- Only for coverings in leather, insert in RIO will be applied (Pic.1). Please refer to the technical sheet in the catalog and in the pricelist.
- Fabric insert in RIO cannot be applied for coverings in fabric. In that case a simple stitching will be realized (Pic.2).
- Fabric insert in RIO cannot be applied for coverings in leather Nobile (or leathers thicker than 1.8 mm). In that case a simple stitching will be realized (Pic.3).
- For all leathers without insert RIO, well be realized a simple stitching (Pic.3).
- Other typologies of combined coverings not available.



Tavolino terminale // Terminal table



Canna di Fucile (Cod.50) // Gunmetal (Cod.50)



Marmo Emperador (Cod.EM) // Emperador marble (Cod.EM)



Marmo Bianco Carrara (Cod.CA) // White Carrara marble (Cod.CA)



Contenitore in legno // Wooden storage



Noce Canaletto (Cod.10) // Canaletto Walnut (Cod.10)



Poggiatesta // Headrest

### Cuciture // Stitching

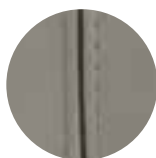

Fig. 1



Fig. 2

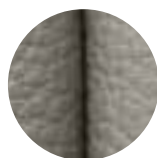

Fig. 3

### Colori per inserto Rio (Fig.1) // Color option for insert Rio (Fig.1)



Cod.100



Cod.603



Cod.415



Cod.413



Cod.801



Cod.610



Cod.717



Cod.626



Cod.200

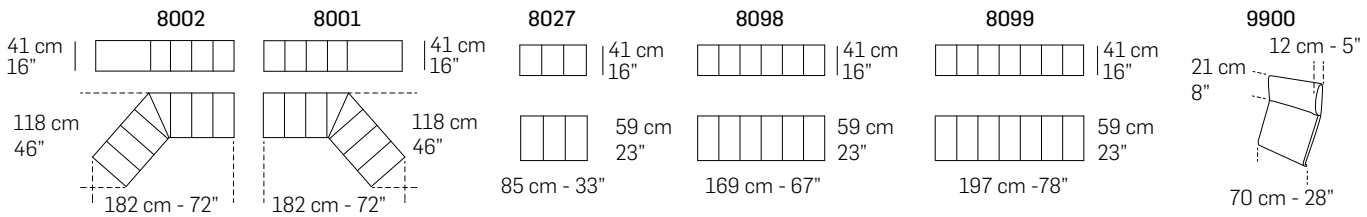
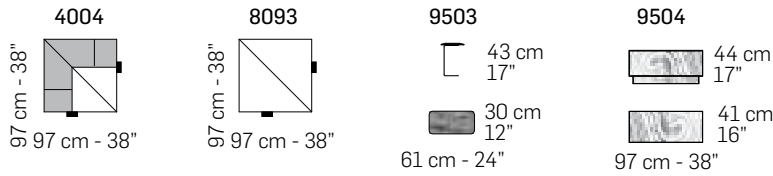
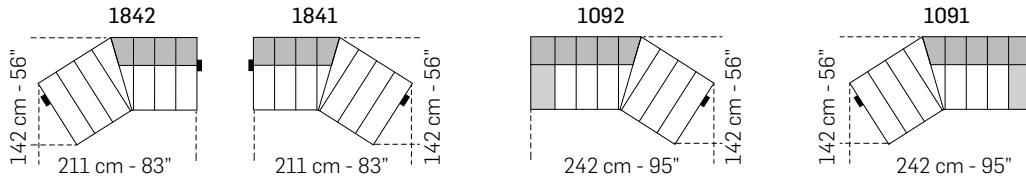
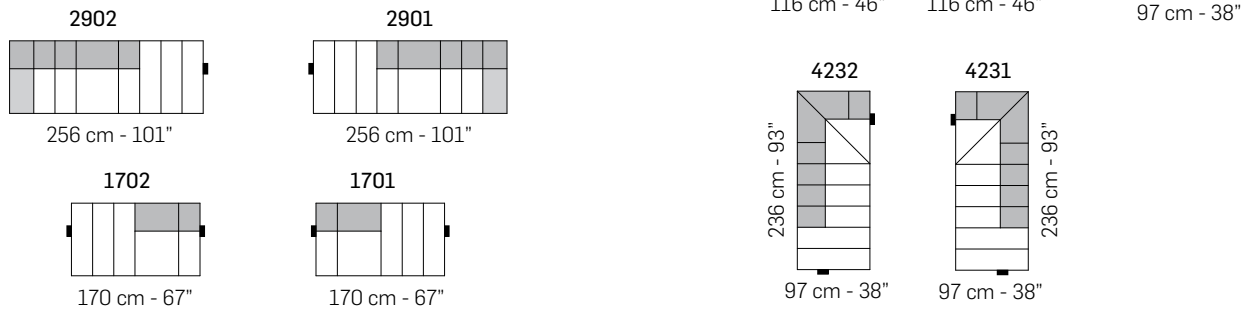
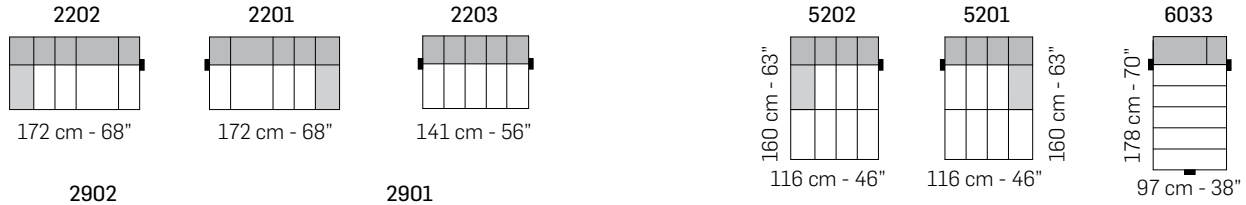
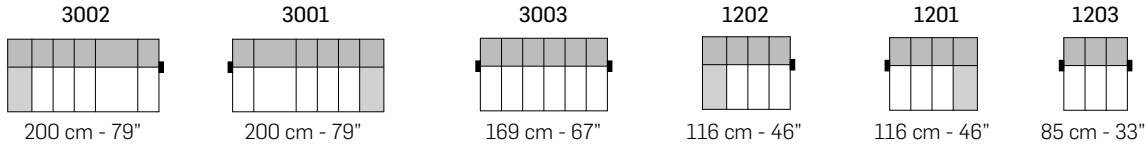
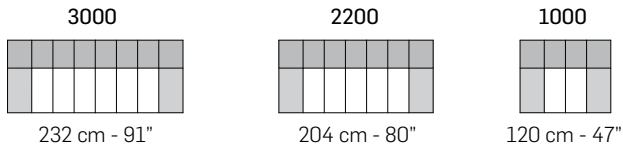

COMPOSIZIONI CONSIGLIATE / SUGGESTED COMPOSITIONS

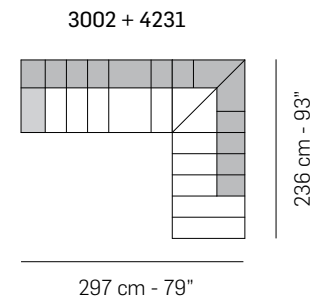
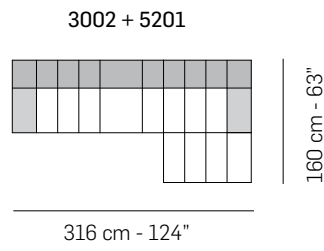
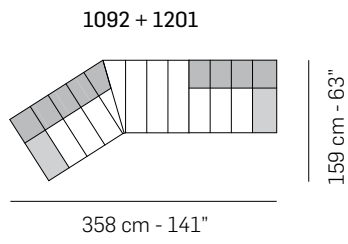

Scala 1:100  
Ratio 1 to 100

Legenda / Legend

- |   |                        |                                  |
|---|------------------------|----------------------------------|
| Spalliera / Back Cushions   | Bracciolo / Armrest    | Marmo / Marble                   |
| Poggiareni / Kidneyrest   | Seduta / Seat Cushions | Legno / Wood                     |
| ⊗ Lato terminale sempre rifinito e agganciabile agli elementi componibili / Terminal side is always finished and it can also be connected to modular elements |                        | Aggancio Componibile / Connector |

Note / Notes

Nicoline si riserva il diritto di apportare in ogni momento modifiche tecniche ed estetiche / Nicoline reserves the right to change, at any time and without prior warning, technical and aesthetic specifications of the articles.



# ZARA DEEP

Design Application N° 402018000002313

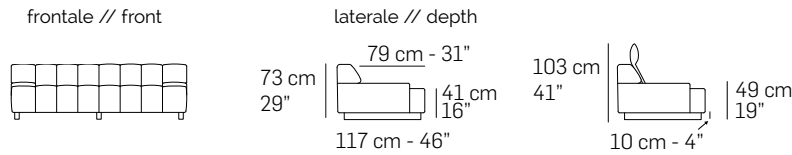

### Caratteristiche standard

- Struttura in legno e multistrato, molleggio seduta e schienale con cinghie elastiche.
- Imbottitura in poliuretano espanso ecologico a cellula aperta con densità differenziate.
- Rivestimento in pelle o tessuto. Tutti i rivestimenti sono fissi.
- Piedi in legno Laccato nero lucido (Cod.27).
- Il tavolino centrale Cod.9504 è disponibile con finitura Noce canaletto (Cod.10).
- Inserimento letto non possibile.
- Lato componibile rifinito.

### Caratteristiche optional su richiesta senza maggiorazione

- Disponibile con cucitura a contrasto. Per la scelta del colore fare riferimento ai codici del campionario pelli.

### Caratteristiche optional su richiesta con maggiorazione

- Poggiatesta (Cod.9900) con imbottitura in poliuretano espanso e supporto in metallo rivestito.
- Tavolino terminale (Cod.9503) con struttura in metallo Canna di fucile (Cod.50) e ripiano in marmo Emperador (Cod.EM) oppure con marmo Bianco Carrara (Cod.CA) fissato alla struttura, per le versioni Cod.D1091 - D1092 - D1701 - D1702 - D1841 - D1842 - D2901 - D2902 - D8001 - D8002.

### Note

- Solo per il rivestimento in pelle, sarà realizzato l'inserito in RIO (Fig.1). Per la scelta del colore fare riferimento alla scheda in catalogo e in listino.
- NON è possibile realizzare l'inserito in RIO per il rivestimento in tessuto. In tal caso sarà realizzata cucitura semplice (Fig.2).
- NON è possibile realizzare l'inserito in RIO per il rivestimento in pelle NOBILE e con spessori di pelle superiori a 1.8 mm. In tal caso sarà realizzata cucitura semplice (Fig.3).
- Per tutte le pelli senza inserto RIO, sarà realizzata una cucitura semplice (Fig. 3)
- Non è possibile realizzare altre tipologie di rivestimento coordinato.

### Standard features

- Frame: wooden structure, seat and back suspensions in reinforced elastic webbing.
- Padding in eco-friendly open cell polyurethane foam, with different densities.
- Covering: in leather or fabric. Not removable coverings.
- Wooden legs in Black gloss lacquer (Cod.27).
- Central table Cod.9504 available with Canaletto walnut (Cod.10) finishing.
- No bed version available.
- Sectional sides finished.

### Optional features without any upcharge

- Contrast stitching available. Please refer to our leather collection for a thread color indication.

### Optional features with upcharge

- Headrest (Cod.9900) with padding in eco-friendly open cell polyurethane foam and covered metal support.
- Terminal table (Cod.9503) with metal structure in Gunmetal (Cod.50) color and top in Emperador marble (Cod.EM) or White Carrara marble (Cod.CA) attached to the structure available for the versions Cod.D1091 - D1092 - D1701 - D1702 - D1841 - D1842 - D2901 - D2902 - D8001 - D8002.

### Notes

- Only for coverings in leather, insert in RIO will be applied (Pic.1). Please refer to the technical sheet in the catalog and in the pricelist.
- Fabric insert in RIO cannot be applied for coverings in fabric. In that case a simple stitching will be realized (Pic.2).
- Fabric insert in RIO cannot be applied for coverings in leather Nobile (or leathers thicker than 1.8 mm). In that case a simple stitching will be realized (Pic.3).
- For all leathers without insert RIO, well be realized a simple stitching (Pic.3).
- Other typologies of combined coverings not available.



Tavolino terminale // Terminal table



Canna di Fucile (Cod.50) // Gunmetal (Cod.50)



Marmo Emperador (Cod.EM) // Emperador marble (Cod.EM)



Marmo Bianco Carrara (Cod.CA) // White Carrara marble (Cod.CA)



Contenitore in legno // Wooden storage



Noce Caneletto (Cod.10) // Canaletto Walnut (Cod.10)



Poggiatesta // Headrest

### Cuciture // Stitching

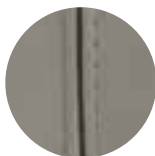

Fig. 1



Fig. 2

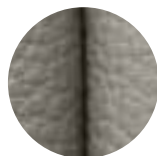

Fig. 3

Colori per inserto Rio (Fig.1) // Color option for insert Rio (Fig.1)



Cod.100



Cod.603



Cod.415



Cod.413



Cod.801



Cod.610



Cod.717



Cod.626



Cod.200



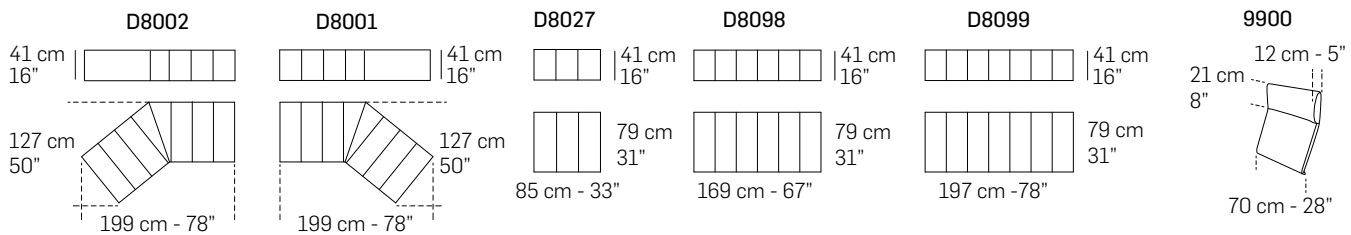
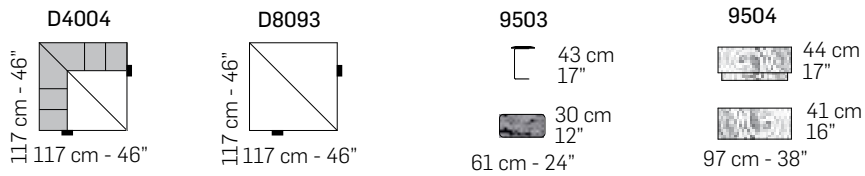
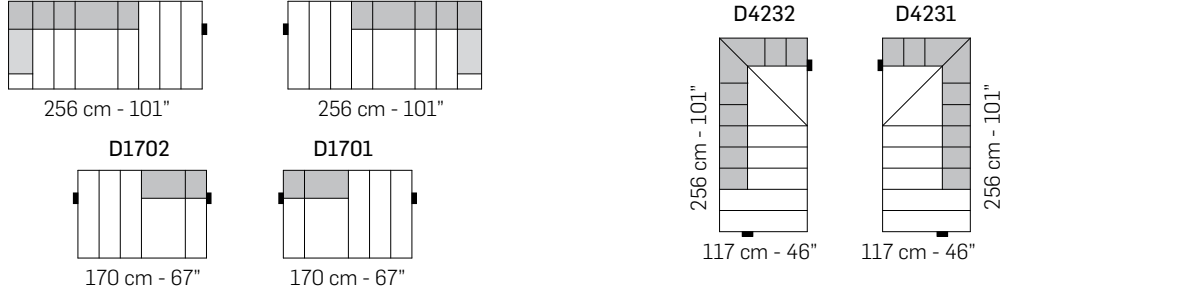
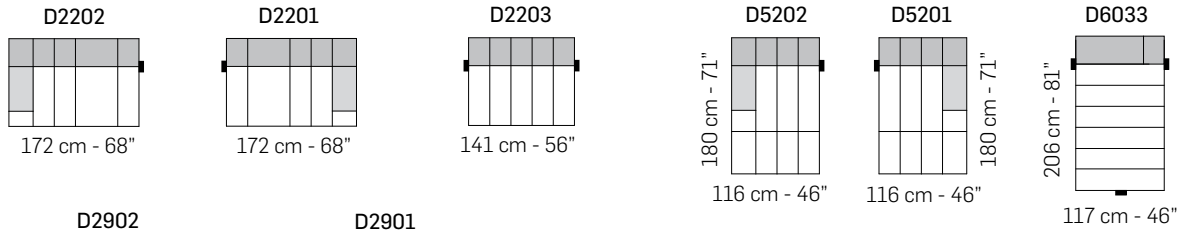
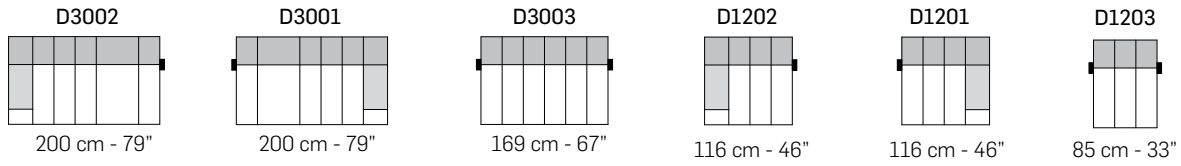
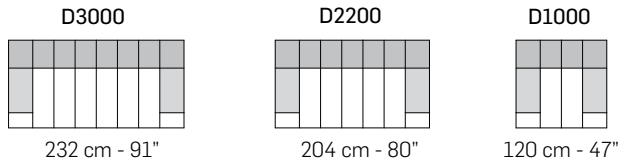

COMPOSIZIONI CONSIGLIATE / SUGGESTED COMPOSITIONS

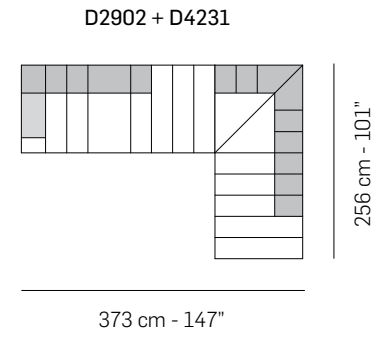
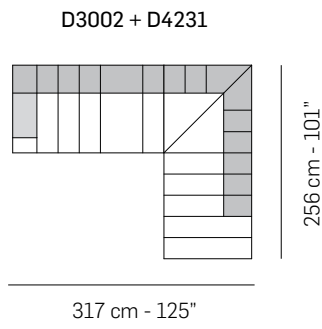
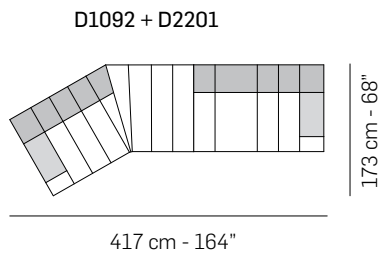

Scala 1:100  
Ratio 1 to 100

Legenda / Legend

- |   |                        |                                  |
|---|------------------------|----------------------------------|
| Spalliera / Back Cushions   | Bracciolo / Armrest    | Marmo / Marble                   |
| Poggiareni / Kidneyrest   | Seduta / Seat Cushions | Legno / Wood                     |
| ⊗ Lato terminale sempre rifinito e agganciabile agli elementi componibili / Terminal side is always finished and it can also be connected to modular elements |                        | Aggancio Componibile / Connector |

Note / Notes

Nicoline si riserva il diritto di apportare in ogni momento modifiche tecniche ed estetiche / Nicoline reserves the right to change, at any time and without prior warning, technical and aesthetic specifications of the articles.



# ZARA LIGHT

Design Application N° 402019000000467

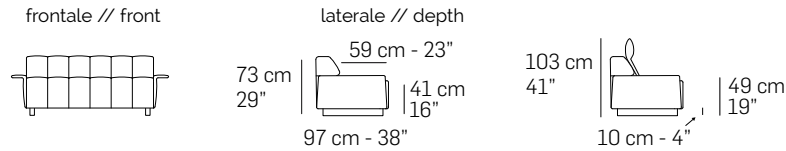

### Caratteristiche standard

- Struttura in legno e multistrato, molleggio seduta e schienale con cinghie elastiche.
- Struttura bracciolo in metallo rivestito in poliuretano espanso.
- Imbottitura in poliuretano espanso ecologico a cellula aperta con densità differenziate.
- Rivestimento in pelle o tessuto. Tutti i rivestimenti sono fissi.
- Per tutte le versioni (dove previsto) il bracciolo sarà realizzato esclusivamente in pelle.
- Piedi in legno Laccato nero lucido (Cod.27).
- Il tavolino centrale Cod.9504 è disponibile con finitura Noce canaletto (Cod.10).
- Inserimento letto non possibile.
- Lato componibile rifinito.

### Caratteristiche optional su richiesta senza maggiorazione

- Disponibile con cucitura a contrasto. Per la scelta del colore fare riferimento ai codici del campionario pelli.

### Caratteristiche optional su richiesta con maggiorazione

- Poggiatesta (Cod.9900) con imbottitura in poliuretano espanso e supporto in metallo rivestito.
- Tavolino terminale (Cod.9503) con struttura in metallo Canna di fucile (Cod.50) e ripiano in marmo Emperador (Cod.EM) oppure con marmo Bianco Carrara (Cod.CA) fissato alla struttura, per le versioni Cod.L1091 - L1092 - L1701 - L1702 - L1791 - L1792 - L1841 - L1842 - L8001 - L8002.

### Note

- Solo per il rivestimento in pelle, sarà realizzato l'inserito in RIO (Fig.1). Per la scelta del colore fare riferimento alla scheda in catalogo e in listino.
- NON è possibile realizzare l'inserito in RIO per il rivestimento in tessuto. In tal caso sarà realizzata cucitura semplice (Fig.2).
- NON è possibile realizzare l'inserito in RIO per il rivestimento in pelle NOBILE e con spessori di pelle superiori a 1.8 mm. In tal caso sarà realizzata cucitura semplice (Fig. 3).
- Per tutte le pelli senza inserto RIO, sarà realizzata una cucitura semplice (Fig. 3).
- Non è possibile realizzare altre tipologie di rivestimento coordinato.

### Standard features

- Frame: wooden structure, seat and back suspensions in reinforced elastic webbing.
- Armrest in metal structure covered with open cell polyurethane foam.
- Padding in eco-friendly open cell polyurethane foam, with different densities.
- Covering in leather or fabric. Not removable coverings.
- For all versions (where applicable) armrest will be realized with covering in leather.
- Wooden legs in Black gloss lacquer (Cod.27).
- Central table Cod.9504 available with Canaletto walnut (Cod.10) finishing.
- No bed version available.
- Sectional sides finished.

### Optional features without any upcharge

- Contrast stitching available. Please refer to our leather collection for a thread color indication.

### Optional features with upcharge

- Headrest (Cod.9900) with padding in eco-friendly open cell polyurethane foam and covered metal support.
- Terminal table (Cod.9503) with metal structure in Gunmetal (Cod.50) color and top in Emperador marble (Cod.EM) or White Carrara marble (Cod.CA) attached to the structure available for the versions Cod.L1091 - L1092 - L1701 - L1702 - L1791 - L1792 - L1841 - L1842 - L8001 - L8002.

### Notes

- Only for coverings in leather, insert in RIO will be applied (Pic.1). Please refer to the technical sheet in the catalog and in the pricelist.
- Fabric insert in RIO cannot be applied for coverings in fabric. In that case a simple stitching will be realized (Pic.2).
- Fabric insert in RIO cannot be applied for coverings in leather Nobile (or leathers thicker than 1.8 mm). In that case a simple stitching will be realized (Pic.3).
- For all leathers without insert RIO, well be realized a simple stitching (Pic.3).
- Other typologies of combined coverings not available.



Tavolino terminale // Terminal table



Canna di Fucile (Cod.50) // Gunmetal (Cod.50)



Marmo Emperador (Cod.EM) // Emperador marble (Cod.EM)



Marmo Bianco Carrara (Cod.CA) // White Carrara marble (Cod.CA)



Contenitore in legno // Wooden storage



Noce Canaletto (Cod.10) // Canaletto Walnut (Cod.10)



Poggiatesta // Headrest

Cuciture // Stitching

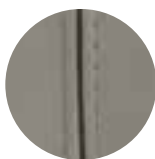

Fig. 1



Fig. 2

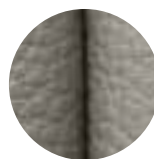

Fig. 3

Colori per inserto Rio (Fig.1) // Color option for insert Rio (Fig.1)



Cod.100



Cod.603



Cod.415



Cod.413



Cod.801



Cod.610



Cod.717



Cod.626



Cod.200

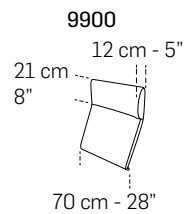
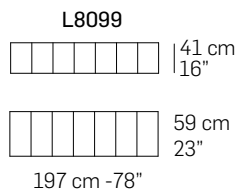
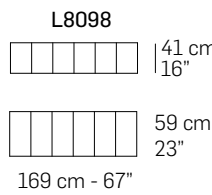
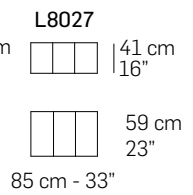
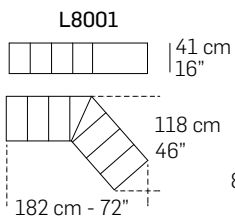
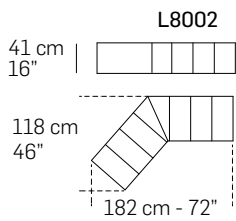
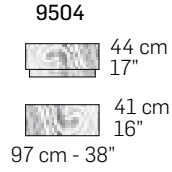
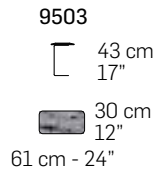
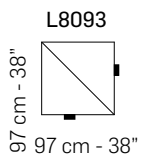
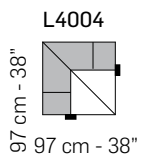
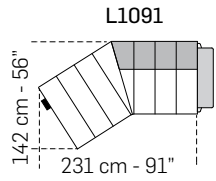
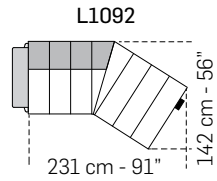
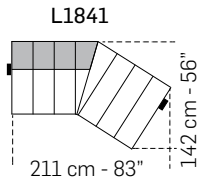
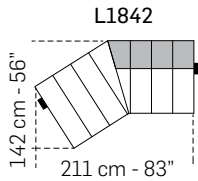
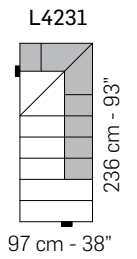
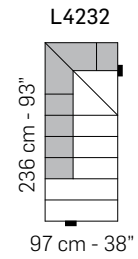
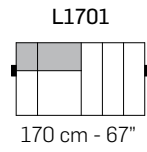
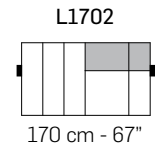
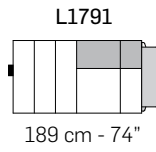
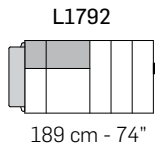
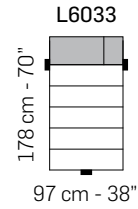
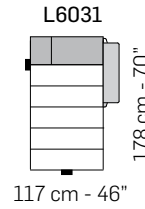
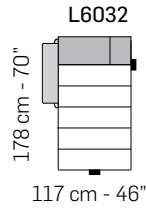
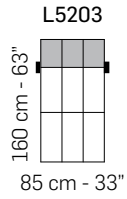
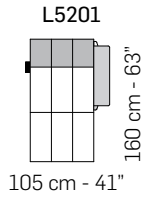
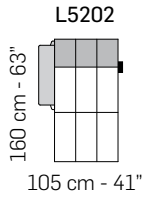
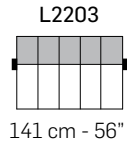
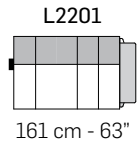
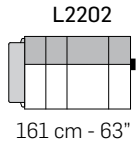
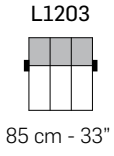
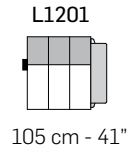
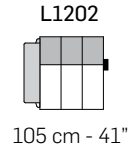
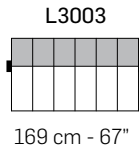
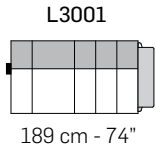
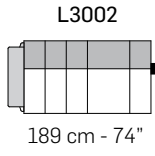
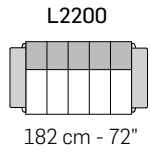
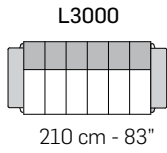

COMPOSIZIONI CONSIGLIATE / SUGGESTED COMPOSITIONS

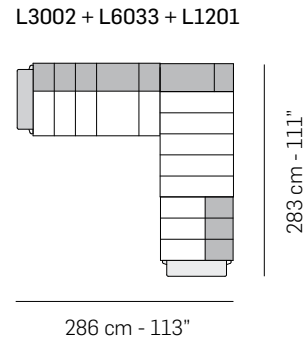
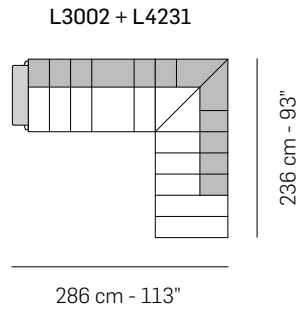
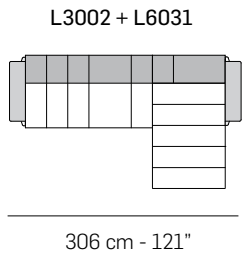

Scala 1:100  
Ratio 1 to 100

Legenda / Legend

- |   |                        |                                  |
|---|------------------------|----------------------------------|
| Spalliera / Back Cushions   | Bracciolo / Armrest    | Marmo / Marble                   |
| Poggiareni / Kidneyrest   | Seduta / Seat Cushions | Legno / Wood                     |
| ⊗ Lato terminale sempre rifinito e agganciabile agli elementi componibili / Terminal side is always finished and it can also be connected to modular elements |                        | Aggancio Componibile / Connector |

Note / Notes

Nicoline si riserva il diritto di apportare in ogni momento modifiche tecniche ed estetiche / Nicoline reserves the right to change, at any time and without prior warning, technical and aesthetic specifications of the articles.





CU58  
9010

60 cm - 24"

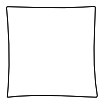

60 cm  
24"

CU57  
9010

50 cm - 20"



50 cm  
20"

**Caratteristiche standard**

- Imbottitura in misto piuma.
- Rivestimento in pelle o tessuto, entrambi sfoderabili.

**Note**

- Multi rivestimento non disponibile.

**Standard Features**

- Padding in mixed feather.
- Covering in leather or fabric. Removable covering.

**Notes**

- Combined coverings not available.



CU52  
9010

60 cm - 24"



60 cm  
24"

CU51  
9010

50 cm - 20"



50 cm  
20"

CU50  
9010

40 cm - 16"



40 cm  
16"

**Caratteristiche standard**

- Imbottitura in fibra di poliestere siliconata.
- Rivestimento in pelle o tessuto, entrambi sfoderabili.

**Note**

- Multi rivestimento non disponibile.

**Standard Features**

- Padding in siliconized polyester fiber.
- Covering in leather or fabric. Removable covering.

**Notes**

- Combined coverings not available.





CU69  
9010

CU68  
9010

CU81  
9010

70 cm - 28"

60 cm - 24"

46 cm - 18"



**Caratteristiche standard**

- Imbottitura in misto piuma.
- Rivestimento in pelle o tessuto, entrambi sfoderabili.

**Note**

- Multi rivestimento non disponibile.

**Standard Features**

- Padding in mixed feather.
- Covering in leather or fabric. Removable covering.

**Notes**

- Combined coverings not available.

**Caratteristiche standard**

- Imbottitura in fibra "Extra soft".
- Rivestimento in pelle o tessuto, entrambi sfoderabili.

**Note**

- Multi rivestimento non disponibile.

**Standard Features**

- Padding in in "Extra soft" fiber.
- Covering in leather or fabric. Removable covering.

**Notes**

- Combined coverings not available.

*Cordinated by Nicoline Marketing Department*

*Photographer Thomas Pagani*

*Printed January 2023*

**nicoline salotti s.r.l.**

C.da Parchi Calia s.n.

Z.I. Pip 70022 Altamura (BA)

T. +39 080 3101487

[info@nicoline.it](mailto:info@nicoline.it)

[www.nicoline.it](http://www.nicoline.it)

La ditta si riserva il diritto di apportare in ogni momento modifiche tecniche ed estetiche.  
La stampa tipografica non sempre permette la fedele riproduzione dei colori e delle tinte rispetto agli originali.

*The company reserves the rights to change, at any time and without prior warning,  
the technical specifications and dimensions of the articles.*



